

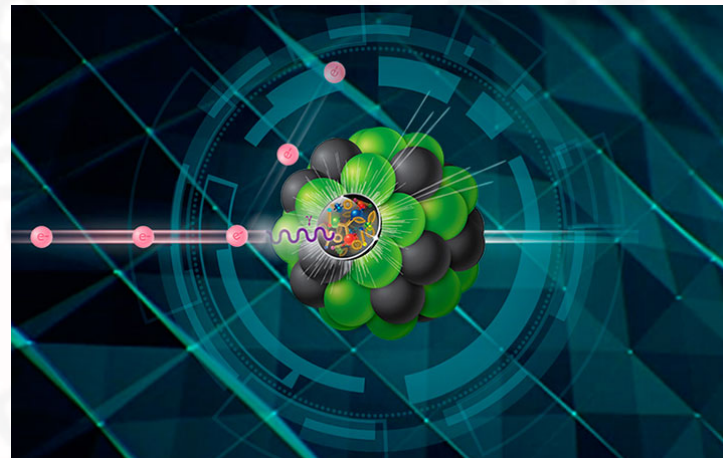

Physics and Detector Overview at the Electron-Ion Collider (EIC) Part II

Bernd Surrow
(surrow@temple.edu)



DOE NP contract: DE-SC0013405

Bernd Surrow

Orientation of Part 1 / Part 2

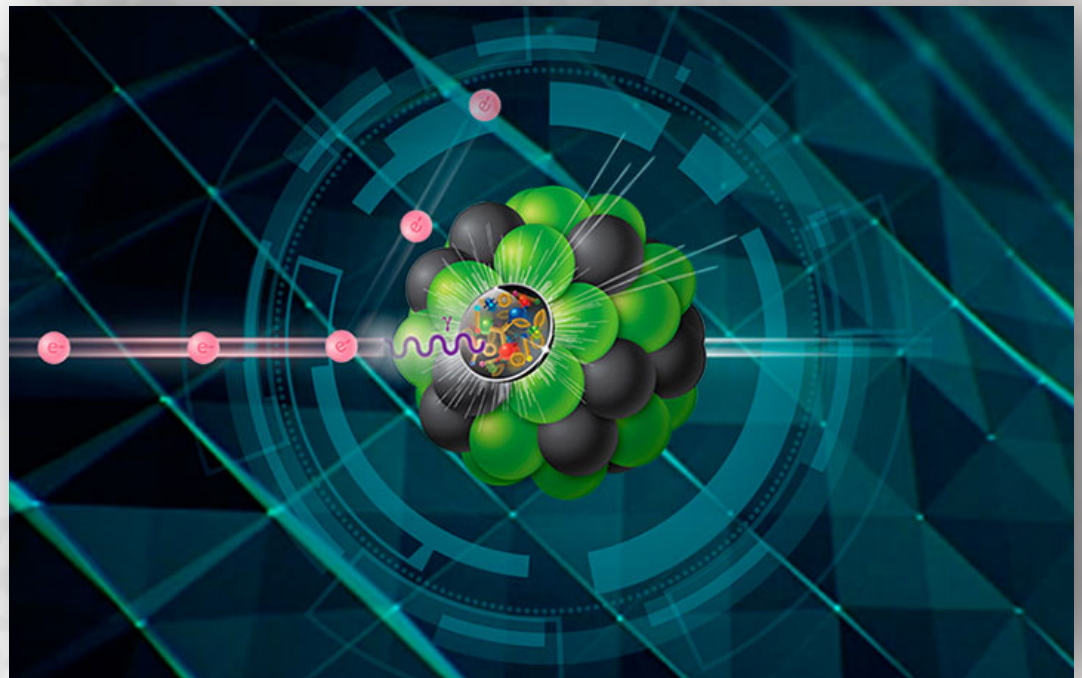

Orientation of Part 1 / Part 2

□ Part 1: **DIS Basics** and

Experimental Aspects

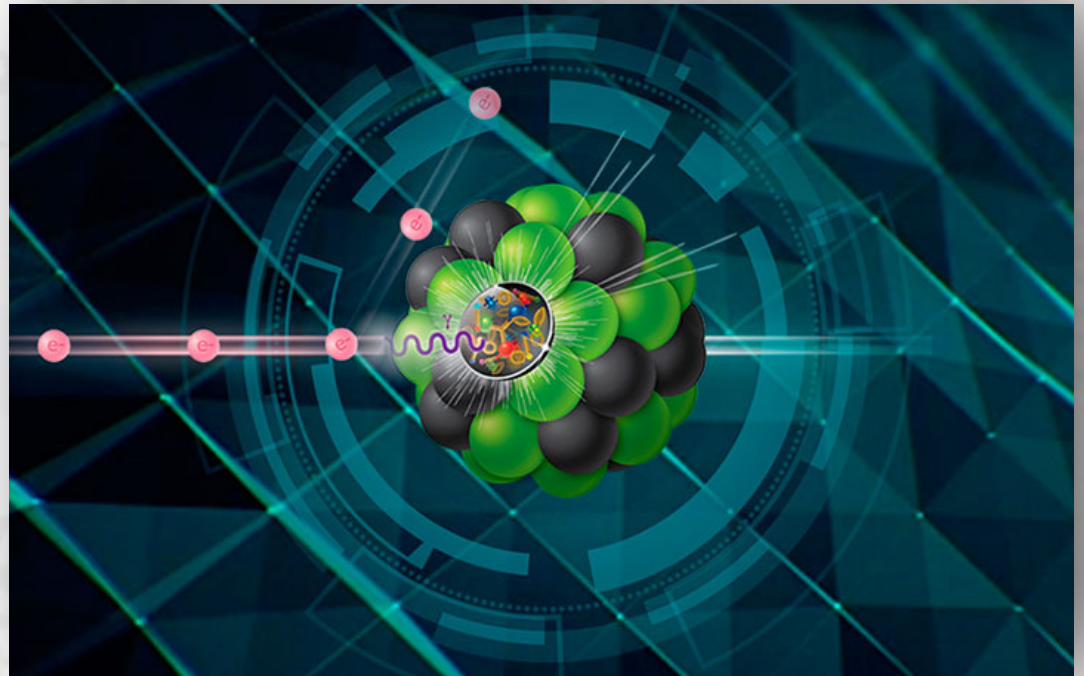

Orientation of Part 1 / Part 2

□ Part 1: **DIS Basics** and

Experimental Aspects

□ Part 2: **EIC Physics** and **Detector**

Realization

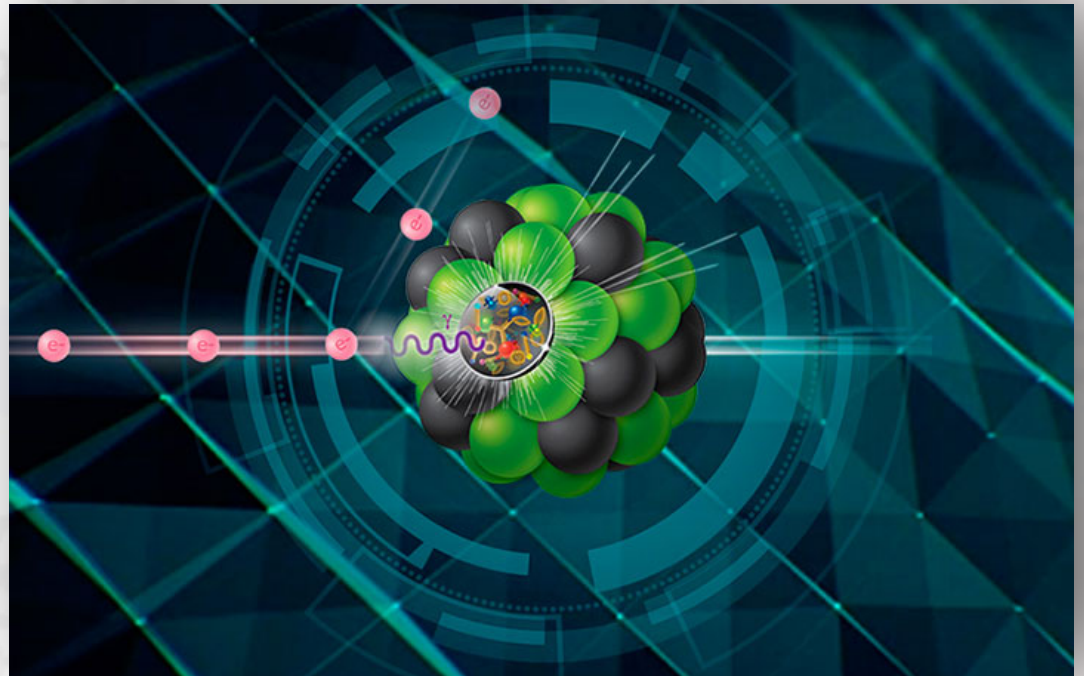

Orientation of Part 1 / Part 2

- Part 1: **DIS Basics** and

Experimental Aspects

- Part 2: **EIC Physics** and **Detector**

Realization

- **Summary**

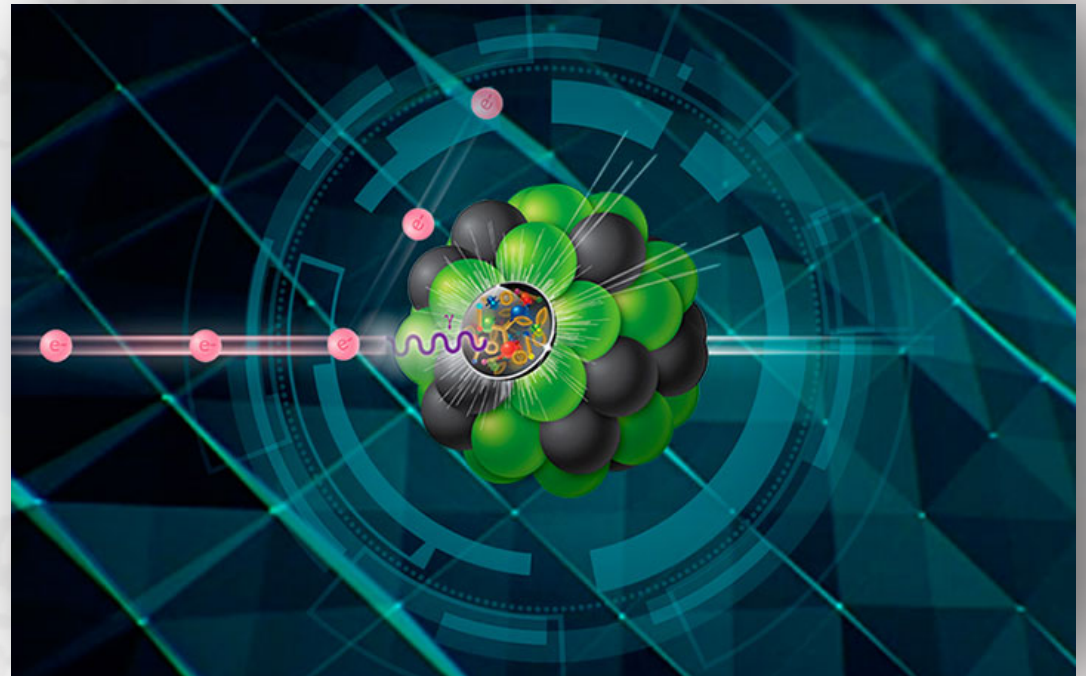

Outline - Part 2

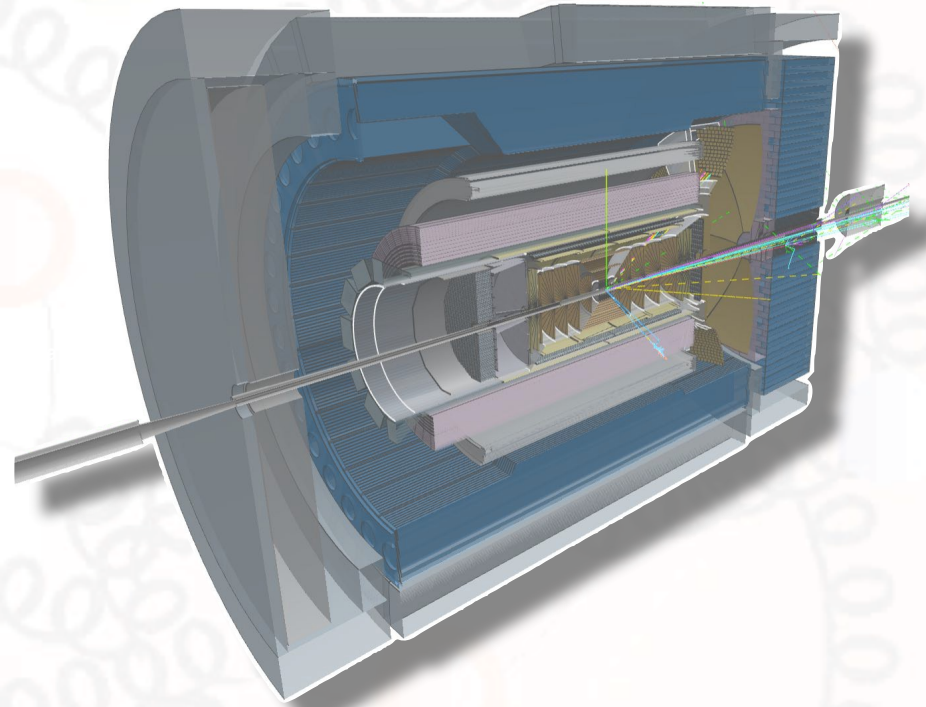

ePIC event display by Dmitry Romanov (JLab)

Outline - Part 2

- Theoretical foundation EIC

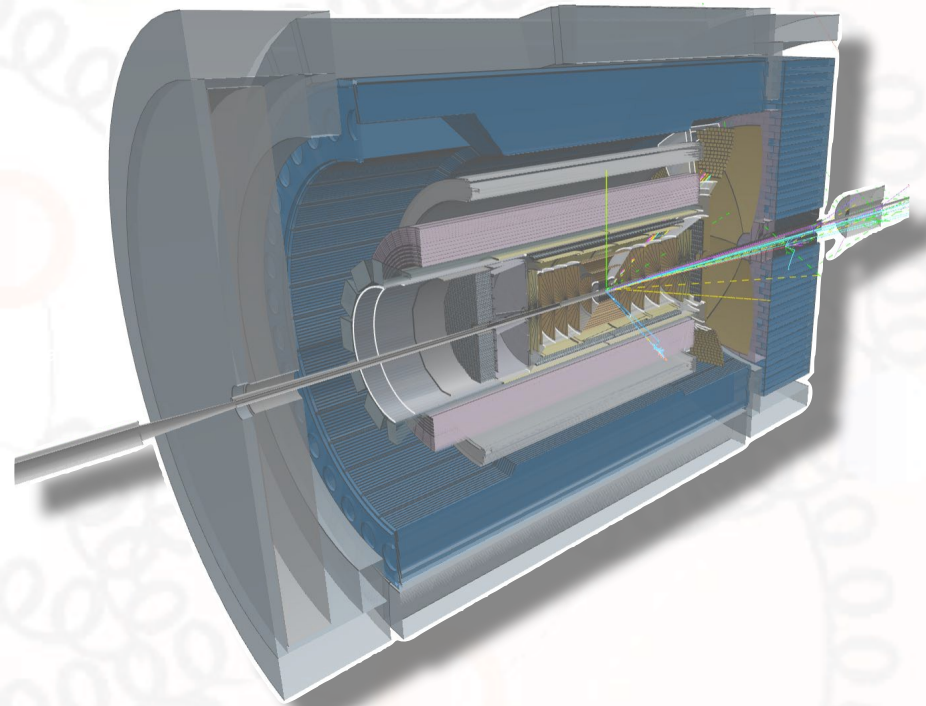

ePIC event display by Dmitry Romanov (JLab)

Outline - Part 2

- Theoretical foundation EIC
- EIC physics case development

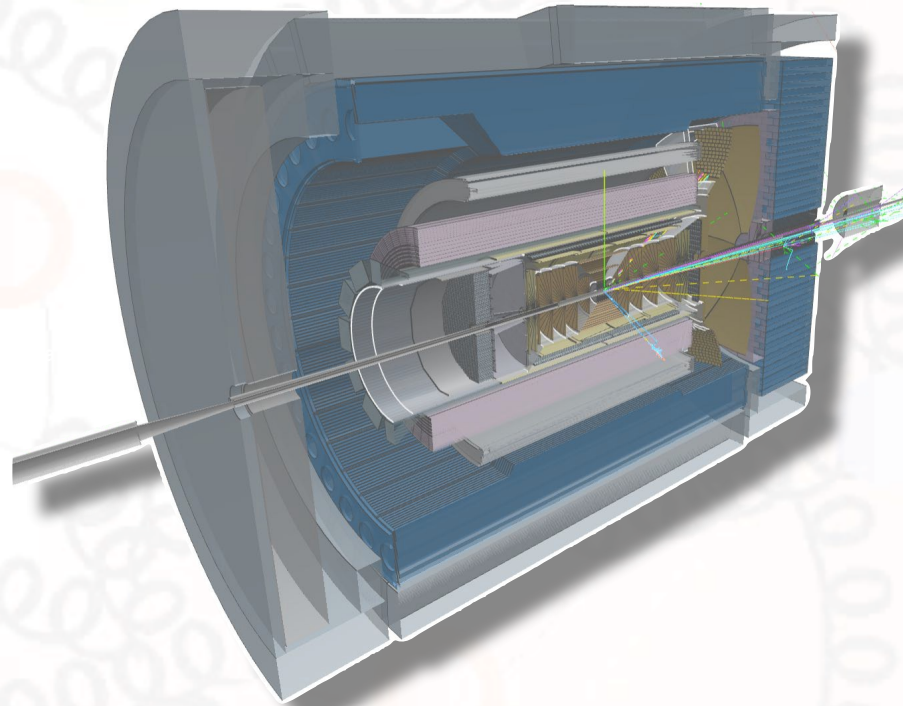

ePIC event display by Dmitry Romanov (JLab)

Outline - Part 2

- Theoretical foundation EIC
- EIC physics case development
- Selected EIC Physics Pillars

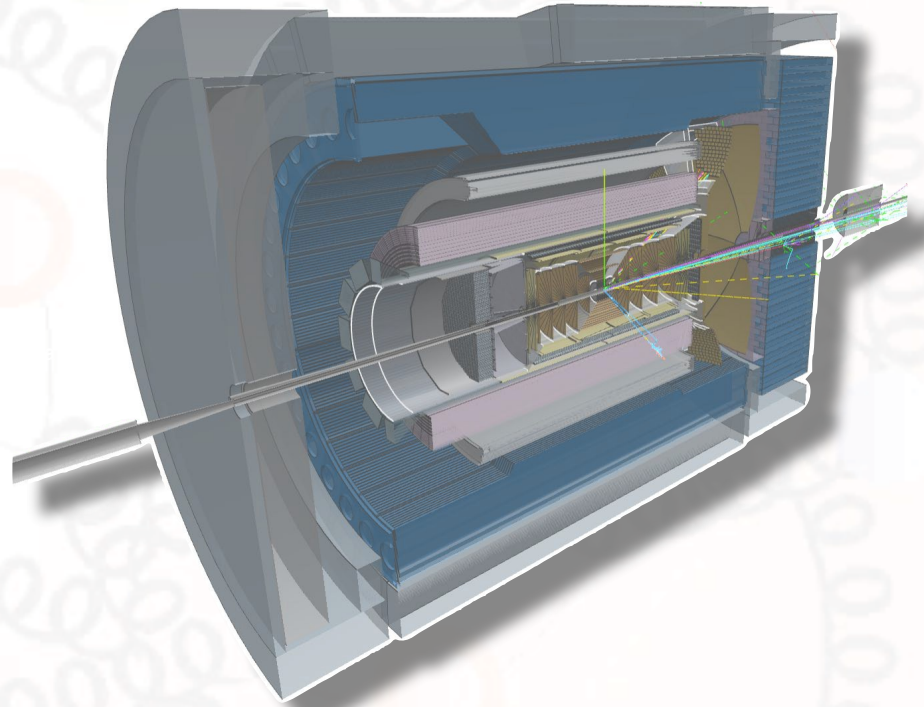

ePIC event display by Dmitry Romanov (JLab)

Outline - Part 2

- Theoretical foundation EIC
- EIC physics case development
- Selected EIC Physics Pillars
 - *Global properties: Mass & Spin*

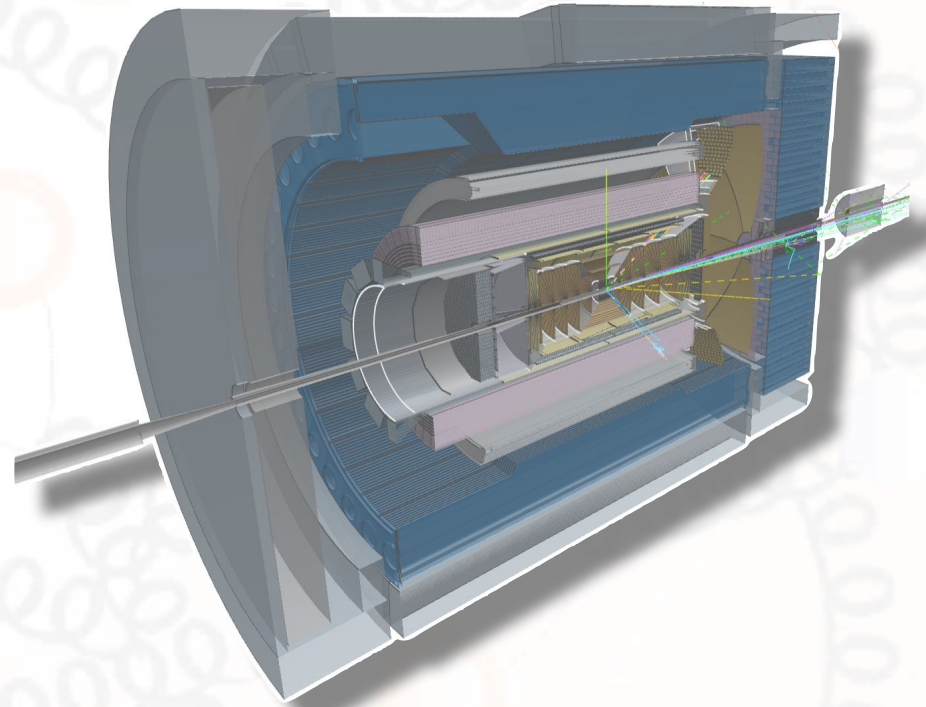

ePIC event display by Dmitry Romanov (JLab)

Outline - Part 2

- Theoretical foundation EIC
- EIC physics case development
- Selected EIC Physics Pillars
 - *Global properties: Mass & Spin*
 - *Nucleon 3D structure*

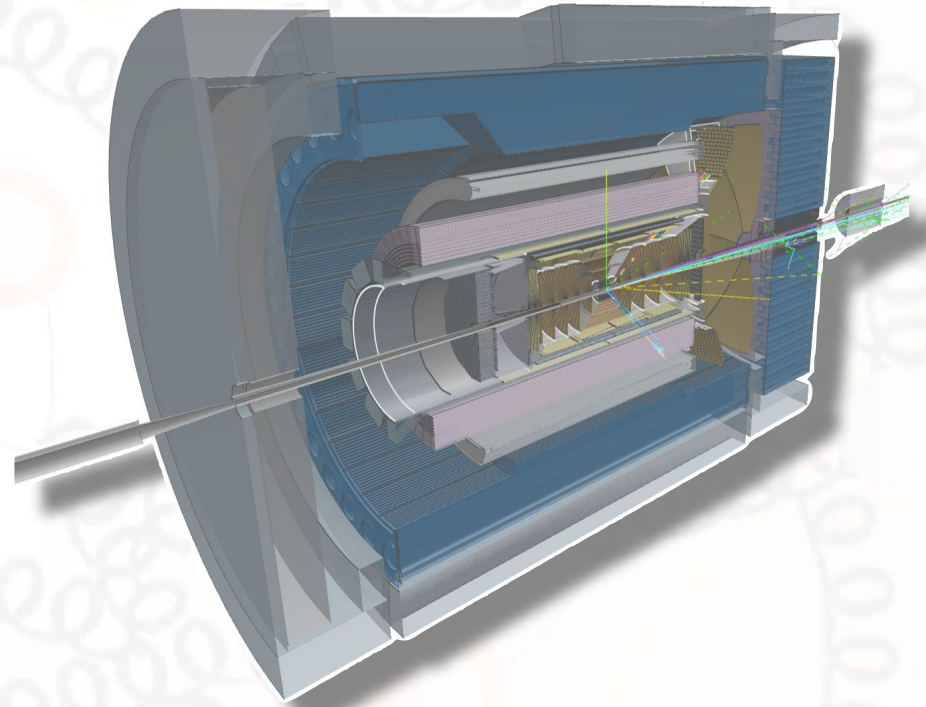

ePIC event display by Dmitry Romanov (JLab)

Outline - Part 2

- Theoretical foundation EIC
- EIC physics case development
- Selected EIC Physics Pillars
 - *Global properties: Mass & Spin*
 - *Nucleon 3D structure*
 - *Low-x physics*

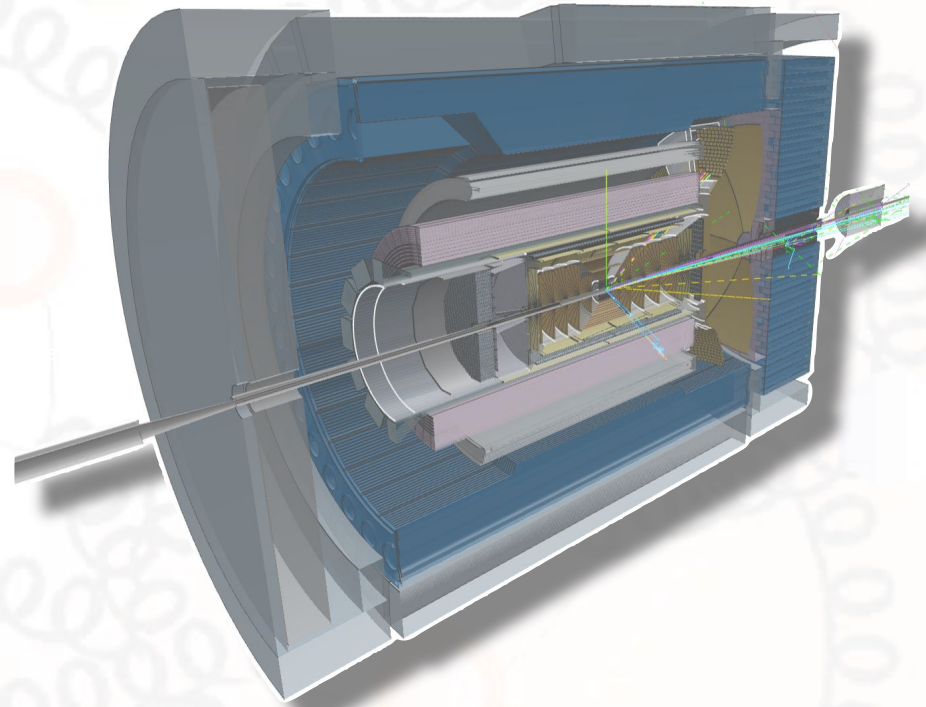

ePIC event display by Dmitry Romanov (JLab)

Outline - Part 2

- Theoretical foundation EIC
- EIC physics case development
- Selected EIC Physics Pillars
 - *Global properties: Mass & Spin*
 - *Nucleon 3D structure*
 - *Low-x physics*
- Experimental Realization

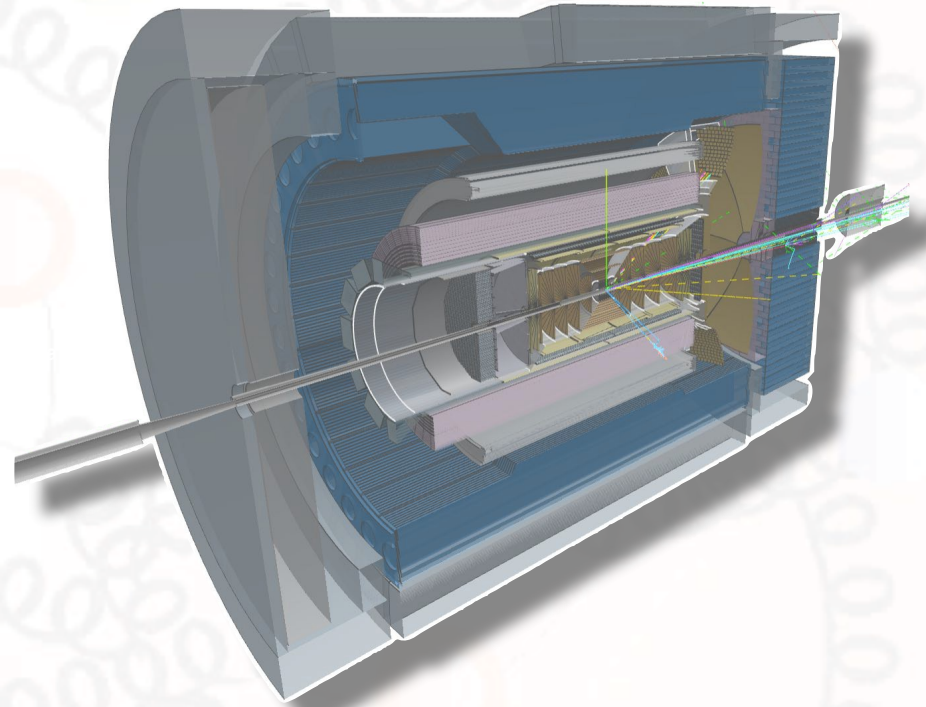

ePIC event display by Dmitry Romanov (JLab)

Outline - Part 2

- Theoretical foundation EIC
- EIC physics case development
- Selected EIC Physics Pillars
 - *Global properties: Mass & Spin*
 - *Nucleon 3D structure*
 - *Low-x physics*
- Experimental Realization
- Summary

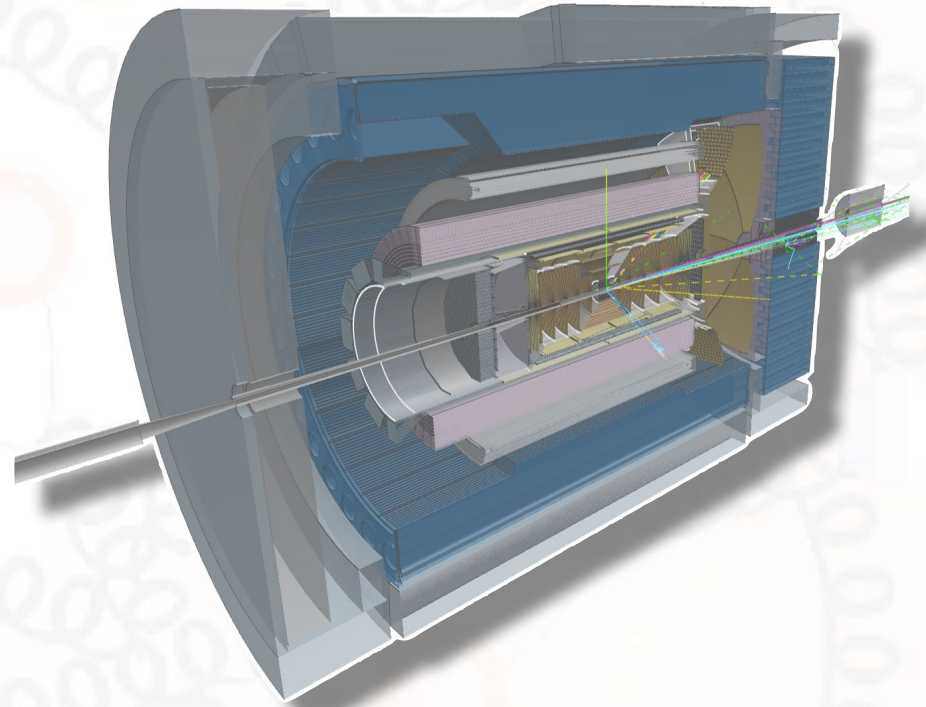

ePIC event display by Dmitry Romanov (JLab)

Theoretical foundation

- EIC - A QCD lab to explore the structure and dynamics of the visible world

$$\mathcal{L}_{QCD} = \sum_{j=1}^{n_f} \bar{\psi}_j (iD_\mu \gamma^\mu - m_j) \psi_j - \frac{1}{4} \text{Tr} G^{\mu\nu} G_{\mu\nu}$$

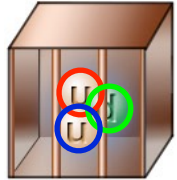

- Interactions arise from fundamental symmetry principles: $SU(3)_c$
- Properties of visible universe such as mass and spin (e.g. proton): Emergent through complex structure of the QCD vacuum

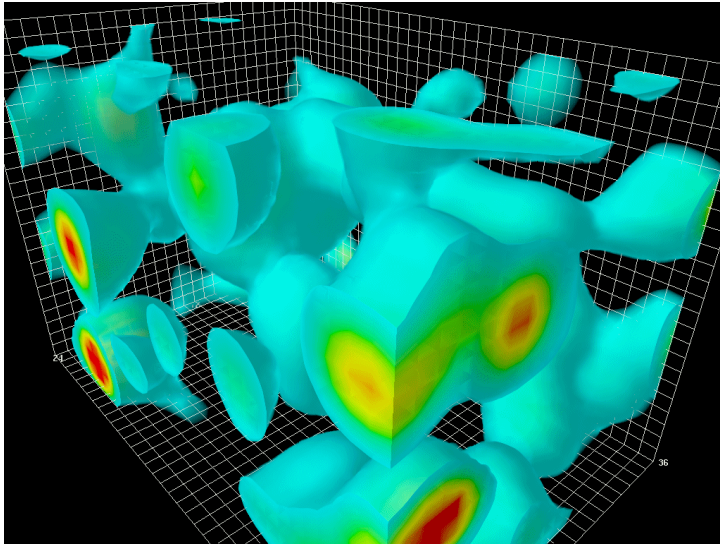

D. Leinweber: Quantum fluctuations in gluon fields

Theoretical foundation

- EIC - A QCD lab to explore the structure and dynamics of the visible world

$$\mathcal{L}_{QCD} = \sum_{j=1}^{n_f} \bar{\psi}_j (iD_\mu \gamma^\mu - m_j) \psi_j - \frac{1}{4} \text{Tr} G^{\mu\nu} G_{\mu\nu}$$

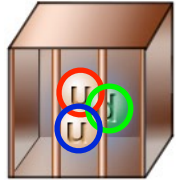

- Interactions arise from fundamental symmetry principles: $SU(3)_c$
- Properties of visible universe such as mass and spin (e.g. proton): Emergent through complex structure of the QCD vacuum

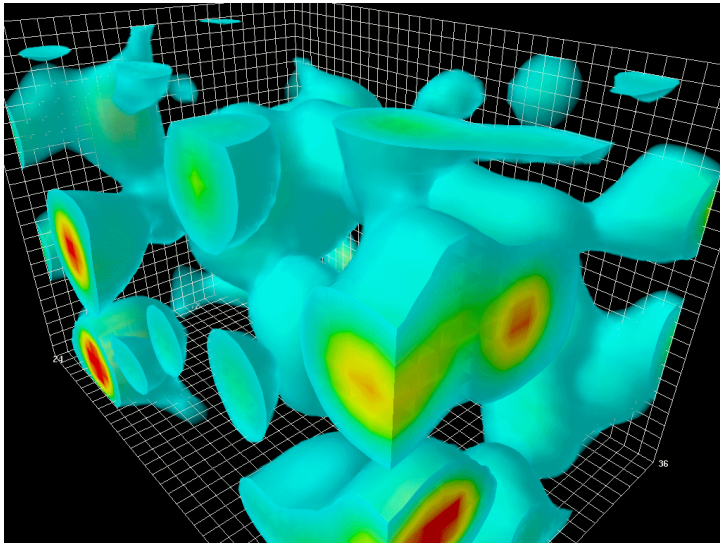

D. Leinweber: Quantum fluctuations in gluon fields

Theoretical foundation

- EIC - A QCD lab to explore the structure and dynamics of the visible world

$$\mathcal{L}_{QCD} = \sum_{j=1}^{n_f} \bar{\psi}_j (iD_\mu \gamma^\mu - m_j) \psi_j - \frac{1}{4} \text{Tr} G^{\mu\nu} G_{\mu\nu}$$

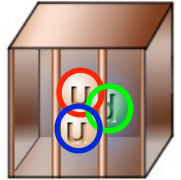

- Interactions arise from fundamental symmetry principles: $SU(3)_c$
 - Properties of visible universe such as mass and spin (e.g. proton): Emergent through complex structure of the QCD vacuum
- Major goal:

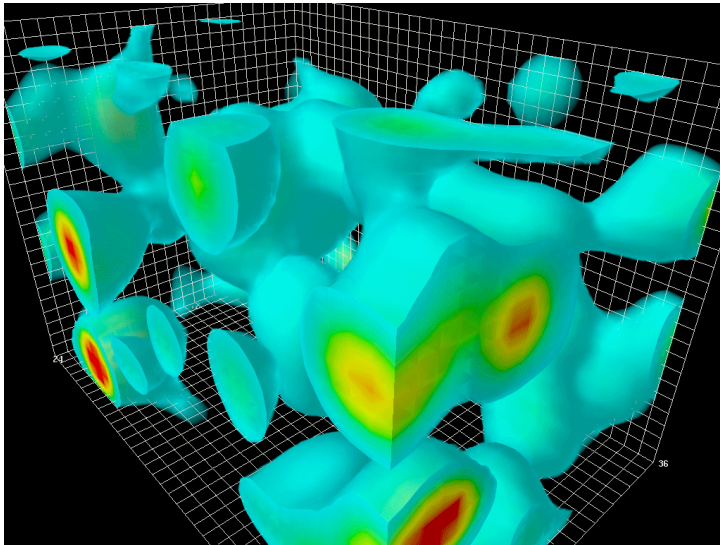

D. Leinweber: Quantum fluctuations in gluon fields

Theoretical foundation

- EIC - A QCD lab to explore the structure and dynamics of the visible world

$$\mathcal{L}_{QCD} = \sum_{j=1}^{n_f} \bar{\psi}_j (iD_\mu \gamma^\mu - m_j) \psi_j - \frac{1}{4} \text{Tr} G^{\mu\nu} G_{\mu\nu}$$

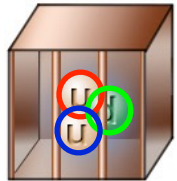

- Interactions arise from fundamental symmetry principles: $SU(3)_c$
- Properties of visible universe such as mass and spin (e.g. proton): Emergent through complex structure of the QCD vacuum

Major goal:

Understanding QCD interactions and emergence of hadronic and nuclear matter in terms of quarks and gluons

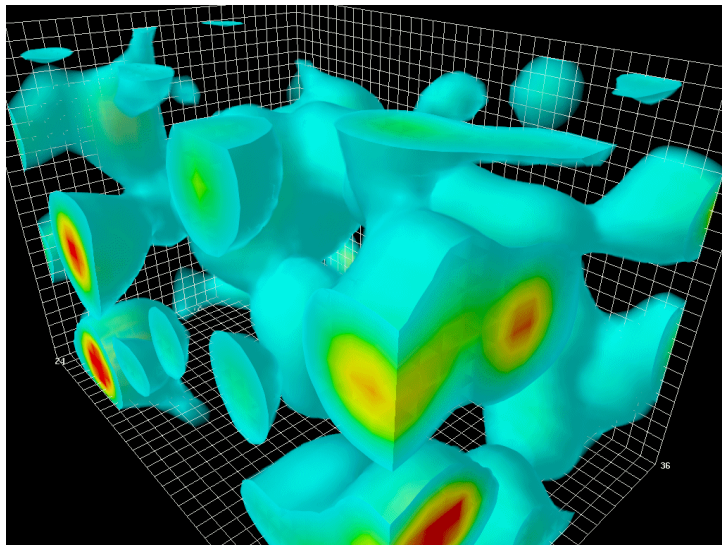

D. Leinweber: Quantum fluctuations in gluon fields

Theoretical foundation

- EIC - A QCD lab to explore the structure and dynamics of the visible world

$$\mathcal{L}_{QCD} = \sum_{j=1}^{n_f} \bar{\psi}_j (iD_\mu \gamma^\mu - m_j) \psi_j - \frac{1}{4} \text{Tr} G^{\mu\nu} G_{\mu\nu}$$

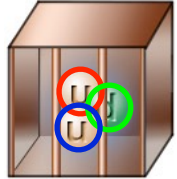

- Interactions arise from fundamental symmetry principles: $SU(3)_c$
- Properties of visible universe such as mass and spin (e.g. proton): Emergent through complex structure of the QCD vacuum

Major goal:

Essential elements looking forward:

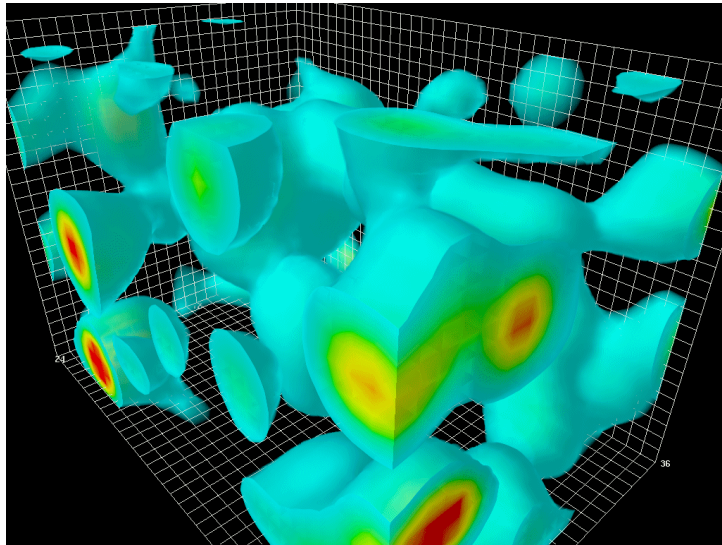

D. Leinweber: Quantum fluctuations in gluon fields

Understanding QCD interactions
and emergence of hadronic and
nuclear matter in terms of quarks
and gluons

Theoretical foundation

- EIC - A QCD lab to explore the structure and dynamics of the visible world

$$\mathcal{L}_{QCD} = \sum_{j=1}^{n_f} \bar{\psi}_j (iD_\mu \gamma^\mu - m_j) \psi_j - \frac{1}{4} \text{Tr} G^{\mu\nu} G_{\mu\nu}$$

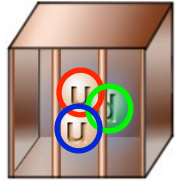

- Interactions arise from fundamental symmetry principles: $SU(3)_c$
- Properties of visible universe such as mass and spin (e.g. proton): Emergent through complex structure of the QCD vacuum

Major goal:

Essential elements looking forward:

Understanding QCD interactions and emergence of hadronic and nuclear matter in terms of quarks and gluons

- 1) Tomography of hadrons and nuclear matter in terms of quarks and gluons

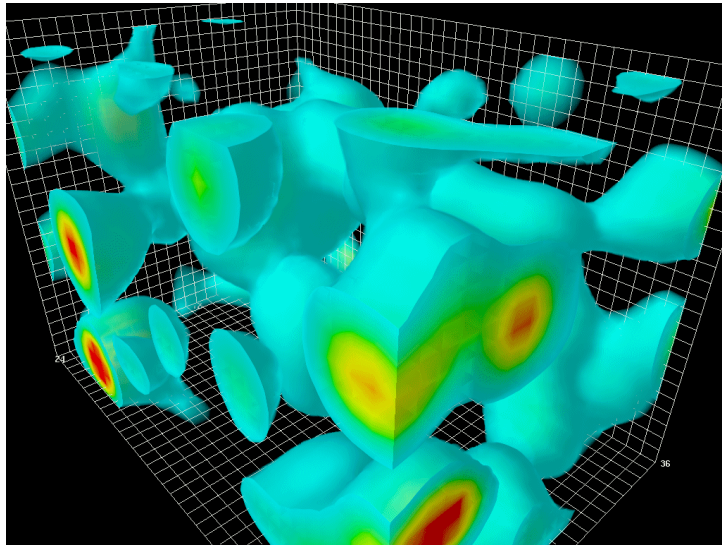

D. Leinweber: Quantum fluctuations in gluon fields

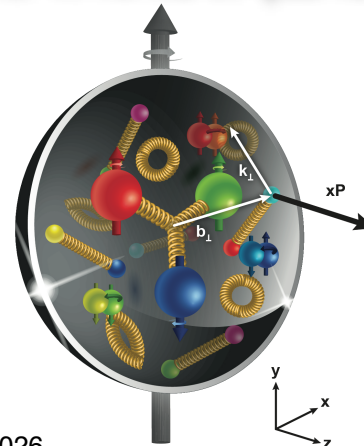

Theoretical foundation

- EIC - A QCD lab to explore the structure and dynamics of the visible world

$$\mathcal{L}_{QCD} = \sum_{j=1}^{n_f} \bar{\psi}_j (iD_\mu \gamma^\mu - m_j) \psi_j - \frac{1}{4} \text{Tr} G^{\mu\nu} G_{\mu\nu}$$

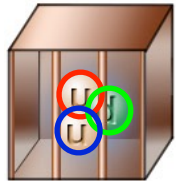

- Interactions arise from fundamental symmetry principles: $SU(3)_c$
- Properties of visible universe such as mass and spin (e.g. proton): Emergent through complex structure of the QCD vacuum

Major goal:

Essential elements looking forward:

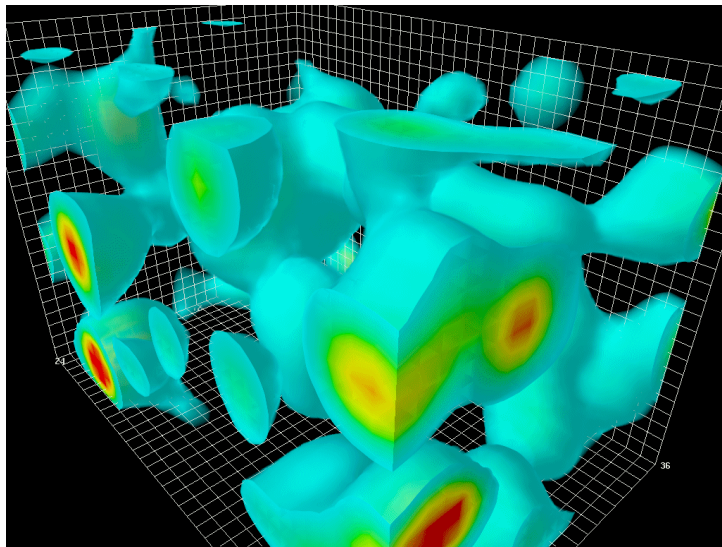

D. Leinweber: Quantum fluctuations in gluon fields

Understanding QCD interactions and emergence of hadronic and nuclear matter in terms of quarks and gluons

- 1) Tomography of hadrons and nuclear matter in terms of quarks and gluons
- 2) Synergy of experimental progress and theory

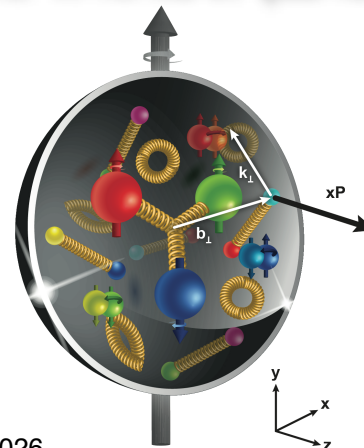

Theoretical foundation

DIS - Parton structure: Unpolarized

H1 and ZEUS Collaborations (H. Abramowicz et al.), Eur.Phys.J. C75 (2015) no.12, 580.

H1 and ZEUS

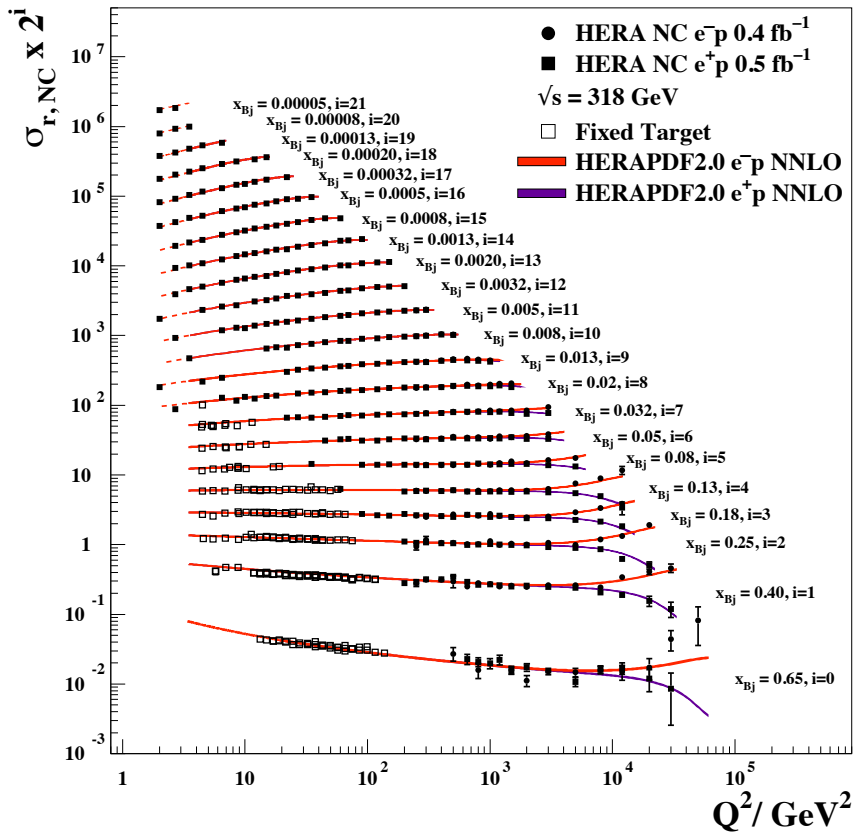

$$d\sigma_{eP} \propto F_2^P = \sum_i e_i^2 x (q_i + \bar{q}_i)$$



1990: J. I. Friedman, H. W. Kendall and R. E. Taylor: "for their pioneering investigations concerning deep inelastic scattering of electrons on protons and bound neutrons, which have been of essential importance for the development of the quark model in particle physics."

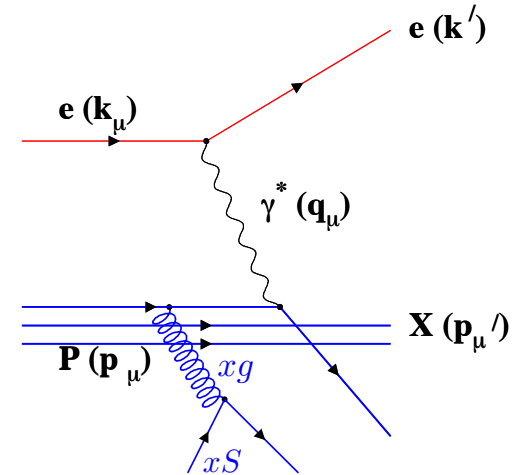

R. D. Ball et al., EPJ C77 (2017) 663.

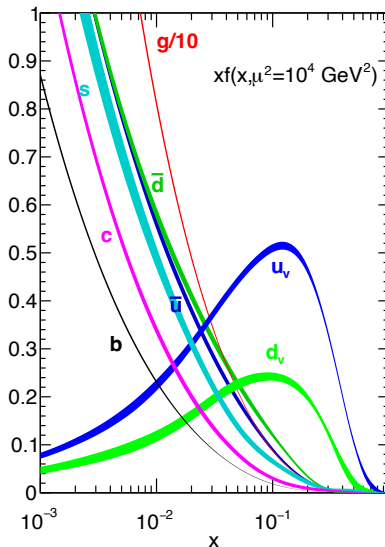
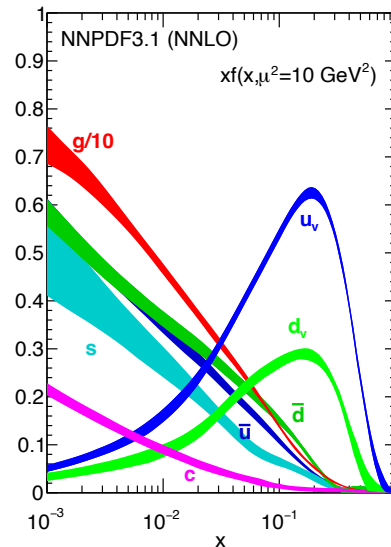

$$f(x) =$$

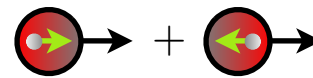

$$f^+(x) + f^-(x)$$

Measure of probability to find parton f with longitudinal momentum fraction x



Theoretical foundation

DIS - Parton structure: Polarized

COMPASS Collaboration (C. Adolph et al.), Phys.Lett. B753 (2016) 18.

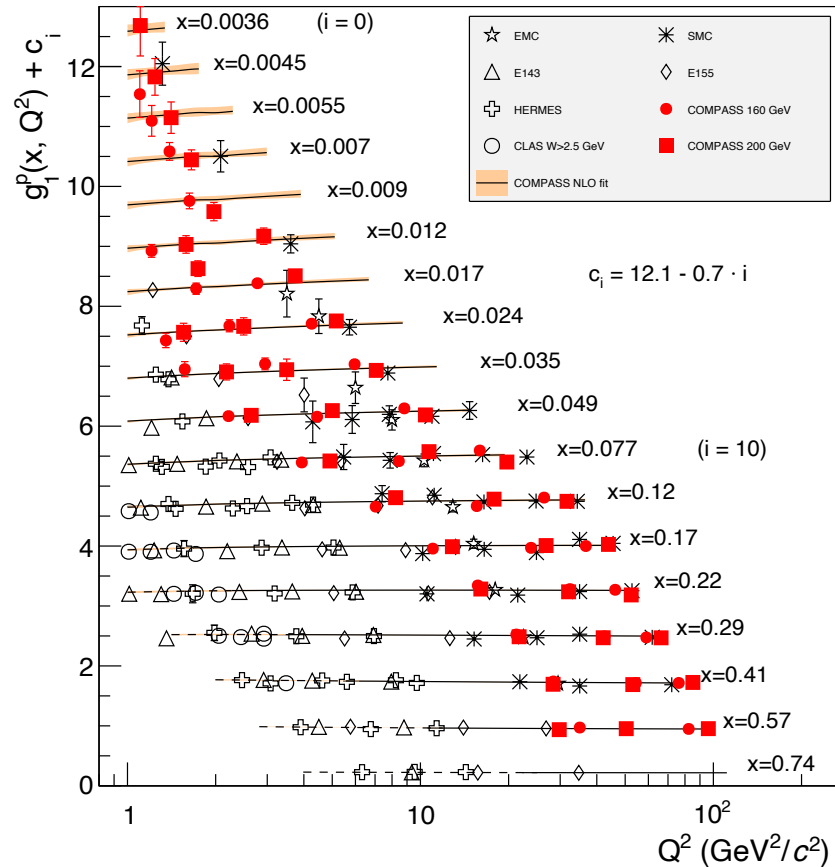

$$g_1^P = \frac{1}{2} \sum_i e_i^2 (\Delta q_i + \Delta \bar{q}_i)$$

$$\frac{1}{2} \Delta \Sigma = \langle S_q \rangle + \langle S_g \rangle + \langle L_q \rangle + \langle L_g \rangle = \Delta G$$

(R.L. Jaffe and A. Manohar, Nucl. Phys. B337, 509 (1990))

$$\Delta \Sigma = \Delta u + \Delta \bar{u} + \Delta d + \Delta \bar{d} + \Delta s + \Delta \bar{s}$$

$$\Delta q_i(Q^2) = \int_0^1 \Delta q_i(x, Q^2) dx$$

$$\Delta G(Q^2) = \int_0^1 \Delta g(x, Q^2) dx$$

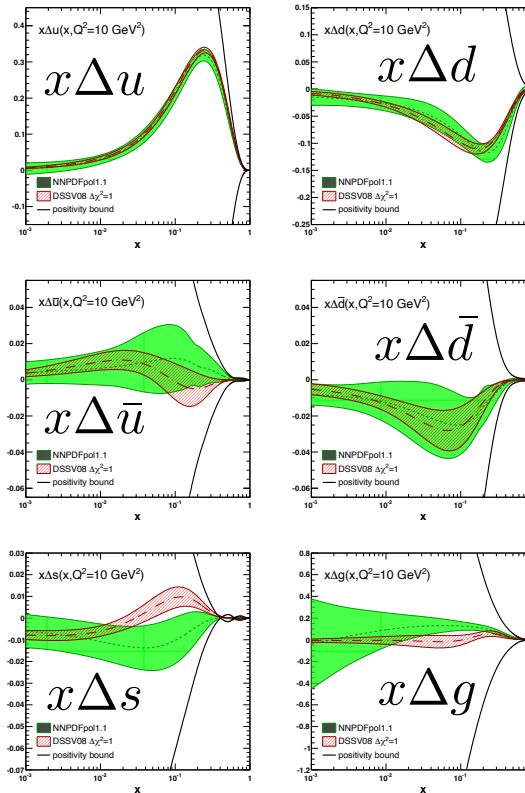

NNPDF Collaboration (Emanuele R. Nocera et al.), Nucl.Phys. B887 (2014) 276-308

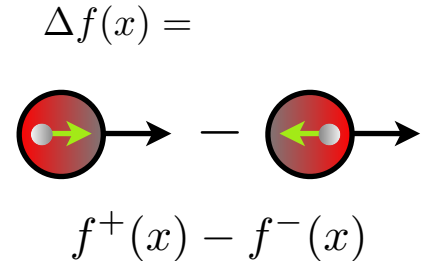

Measure of probability to find parton f with spin aligned to anti-anti-aligned to proton spin at momentum fraction x

EIC physics case development

- Critical steps over the last couple of years - 1
 - INT Workshop series / Documentation of Physics Case - **Whitepaper**: "Understanding the glue that binds us all!"
 - INT Workshop: 2010
 - WP: 2012, updated in 2014 for LRP
 - 2015 Long-range plan (LRP): T. Hallman

arXiv:1212.1701

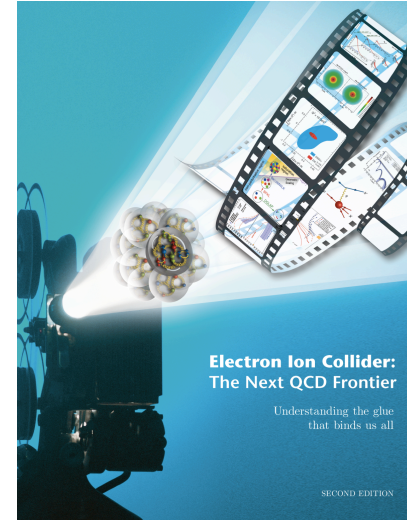

Understanding the glue that binds us all!

T. Hallman

The 2015 Long Range Plan for Nuclear Science

Recommendations:

1. Capitalize on investments made to maintain U.S. leadership in nuclear science.
2. Develop and deploy a U.S.-led ton-scale neutrino-less double beta decay experiment.
3. Construct a high-energy high-luminosity polarized electron-ion collider (EIC) as the highest priority for new construction following the completion of FRIB.
4. Increase investment in small-scale and mid-scale projects and initiatives that enable forefront research at universities and laboratories.

The FY 2018 Request supports progress in important aspects of the 2015 LRP Vision

U.S. DEPARTMENT OF ENERGY | Office of Science | NSAC Meeting | June 2, 2017 | 16

Next Formal Step on the EIC Science Case is Continuing

THE NATIONAL ACADEMIES OF SCIENCES, ENGINEERING, AND MEDICINE
 Division on Engineering and Physical Science
 Board on Physics and Astronomy
U.S.-Based Electron Ion Collider Science Assessment

Summary

The National Academies of Sciences, Engineering, and Medicine ("National Academies") will form a committee to carry out a thorough, independent assessment of the scientific justification for a U.S. domestic electron ion collider facility. In preparing its report, the committee will address the role that such a facility would play in the future of nuclear science, considering the field broadly, but placing emphasis on its potential scientific impact on quantum chromodynamics. The need for such an accelerator will be addressed in the context of international efforts in this area. Support for the 18-month project in the amount of \$540,000 is requested from the Department of Energy.

"U.S.-Based Electron Ion Collider Science Assessment" is now getting underway. The Chair will be Gordon Baym. The rest of the committee, including a co-chair, will be appointed in the next couple of weeks. The first meeting is being planned for January, 2017

U.S. DEPARTMENT OF ENERGY | Office of Science | NSAC Meeting | June 2, 2017 | 19

- Request to review EIC Science Case by National Academy of Sciences, Engineering, and Medicine (NAS)

EIC physics case development

□ NAS Webinar and NAS report release: 07/24/2018

<https://www.nap.edu/catalog/25171/an-assessment-of-us-based-electron-ion-collider-science>

Download pdf-file of
final report!

- Webinar on Tuesday, July 24, 2018 - Public presentation and report release
- Gordon Baym (Co-chair): Webinar presentation

“The committee finds that the science that can be addressed by an EIC is compelling, fundamental and timely.”

- Slides from Webinar: <https://www.nap.edu/resource/25171/eic-public-briefing-slides.pdf>
- Glowing" report on a US-based EIC facility!

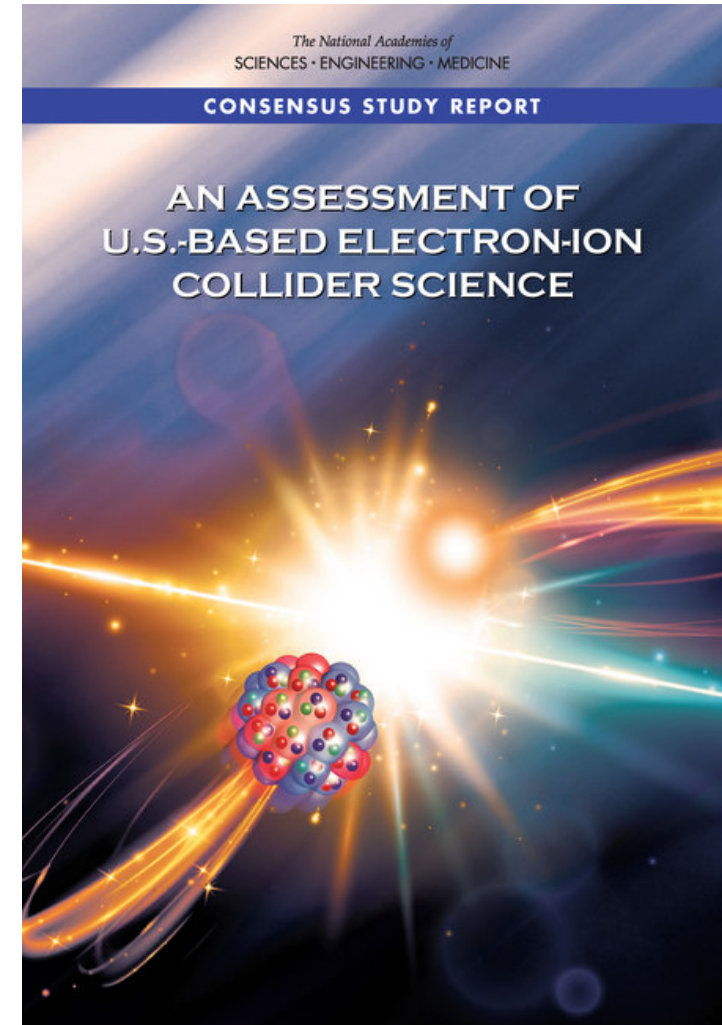

EIC physics case development

□ Volume 1-3: Executive Summary / Physics / Detector

arXiv:2103.05419

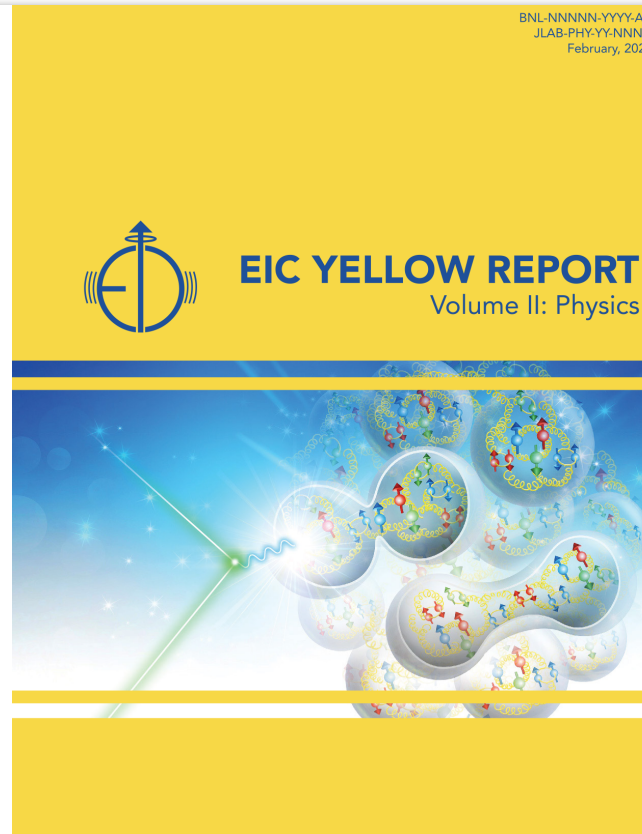

- ~400 authors / ~150 institutions / ~900 pages with strong international contributions!
- Review: **Community review** within EICUG and **external readers** (~30) worldwide covering physics and detector expert fields!
- Available on archive: Nucl. Phys. A 1026 (2022) 122447 / <https://arxiv.org/abs/2103.05419>



EIC Physics Pillars

- Motivation - EIC program



EIC Physics Pillars

□ Motivation - EIC program

How are the sea quarks and gluons, and their spins, **distributed in space and momentum** inside the nucleon?

How do the **nucleon properties emerge** from them and their interactions?

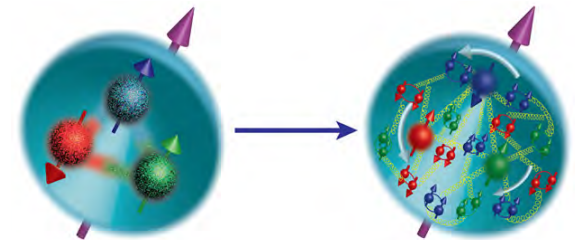

EIC Physics Pillars

□ Motivation - EIC program

How are the sea quarks and gluons, and their spins, **distributed in space and momentum** inside the nucleon?

How do the **nucleon properties emerge** from them and their interactions?

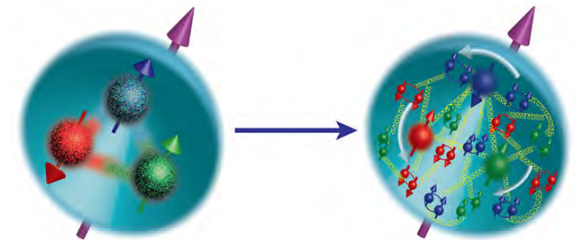
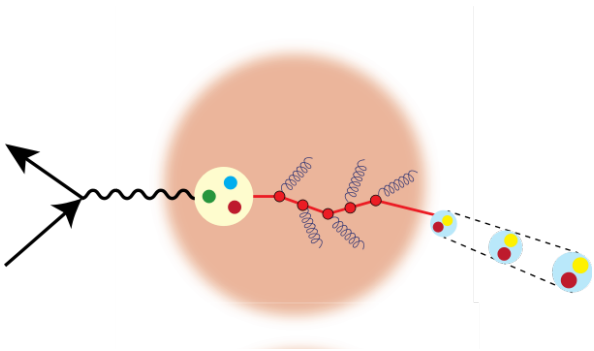

How do color-charged quarks and gluons, and colorless jets, **interact with a nuclear medium**?

How do the **confined hadronic states emerge** from these quarks and gluons?

How do the quark-gluon **interactions create nuclear binding**?

EIC Physics Pillars

□ Motivation - EIC program

How are the sea quarks and gluons, and their spins, **distributed in space and momentum** inside the nucleon?

How do the **nucleon properties emerge** from them and their interactions?

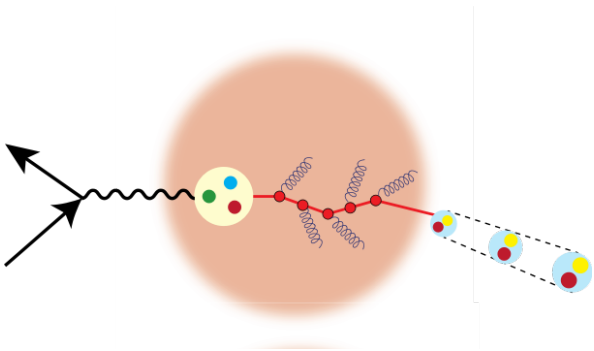

How do color-charged quarks and gluons, and colorless jets, **interact with a nuclear medium**?

How do the **confined hadronic states emerge** from these quarks and gluons?

How do the quark-gluon **interactions create nuclear binding**?

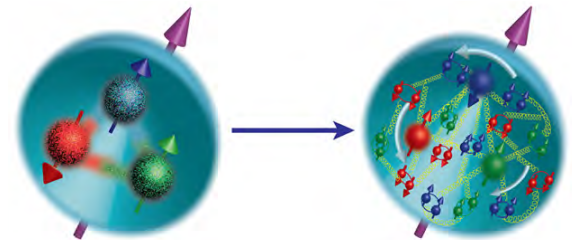

How does a **dense nuclear environment affect** the quarks and gluons, their correlations, and their interactions?

What happens to the **gluon density in nuclei**? Does it **saturate at high energy**, giving rise to a **gluonic matter with universal properties** in all nuclei, even the proton?

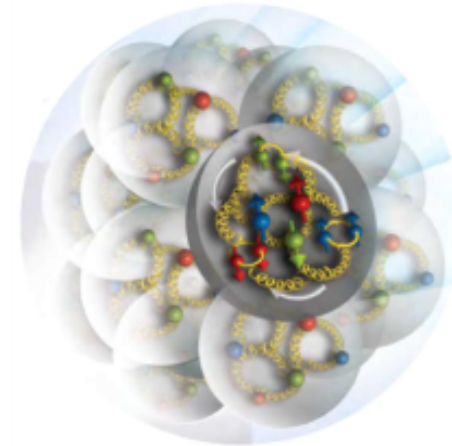



EIC Physics Pillars



EIC Physics Pillars

- EIC: Study structure and dynamics of matter at *high luminosity*, *high energy* with *polarized beams* and *wide range of nuclei*
- Whitepaper:

EIC Physics Pillars

- EIC: Study structure and dynamics of matter at **high luminosity**, **high energy** with **polarized beams** and **wide range of nuclei**

- Whitepaper:

[arXiv:1212.1701](https://arxiv.org/abs/1212.1701)

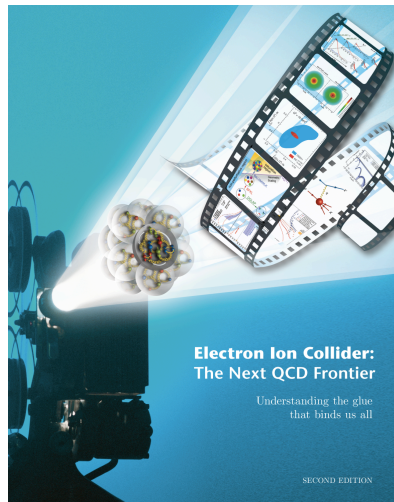

**Understanding
the glue that
binds as all!**

EIC Physics Pillars

- EIC: Study structure and dynamics of matter at **high luminosity**, **high energy** with **polarized beams** and **wide range of nuclei**

- Whitepaper:

[arXiv:1212.1701](https://arxiv.org/abs/1212.1701)

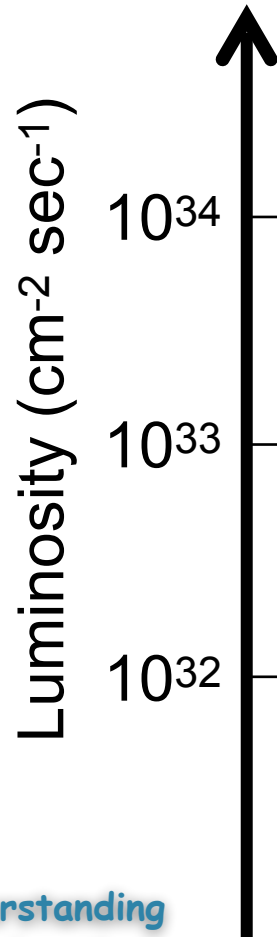

Understanding
the glue that
binds as all!

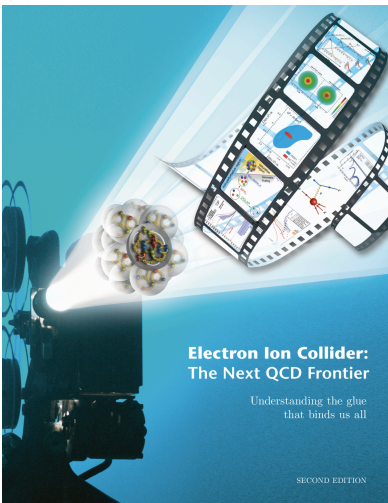

EIC Physics Pillars

- EIC: Study structure and dynamics of matter at **high luminosity**, **high energy** with **polarized beams** and **wide range of nuclei**

- Whitepaper:

[arXiv:1212.1701](https://arxiv.org/abs/1212.1701)

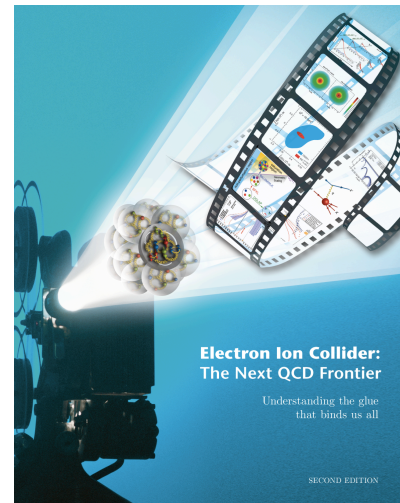

Understanding
the glue that
binds as all!

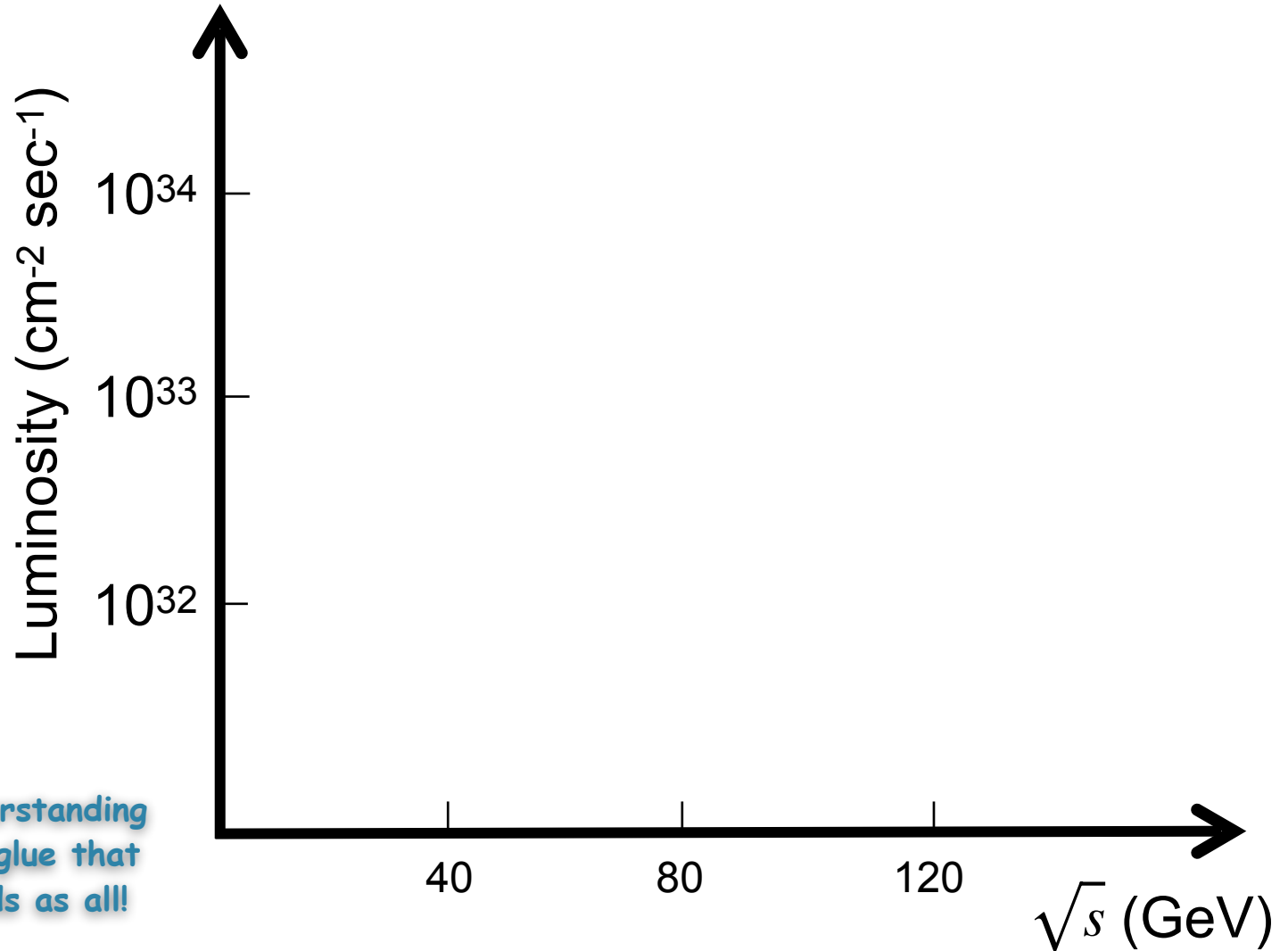

EIC Physics Pillars

- EIC: Study structure and dynamics of matter at **high luminosity**, **high energy** with **polarized beams** and **wide range of nuclei**

- Whitepaper:

[arXiv:1212.1701](https://arxiv.org/abs/1212.1701)

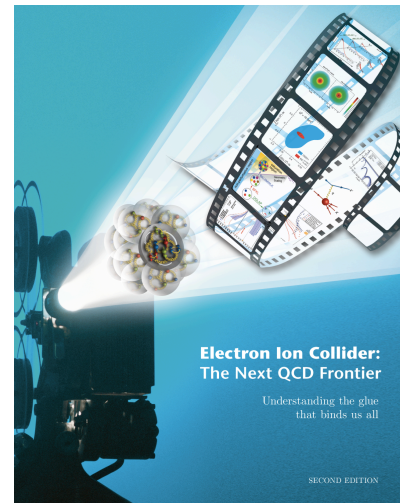

Understanding
the glue that
binds as all!

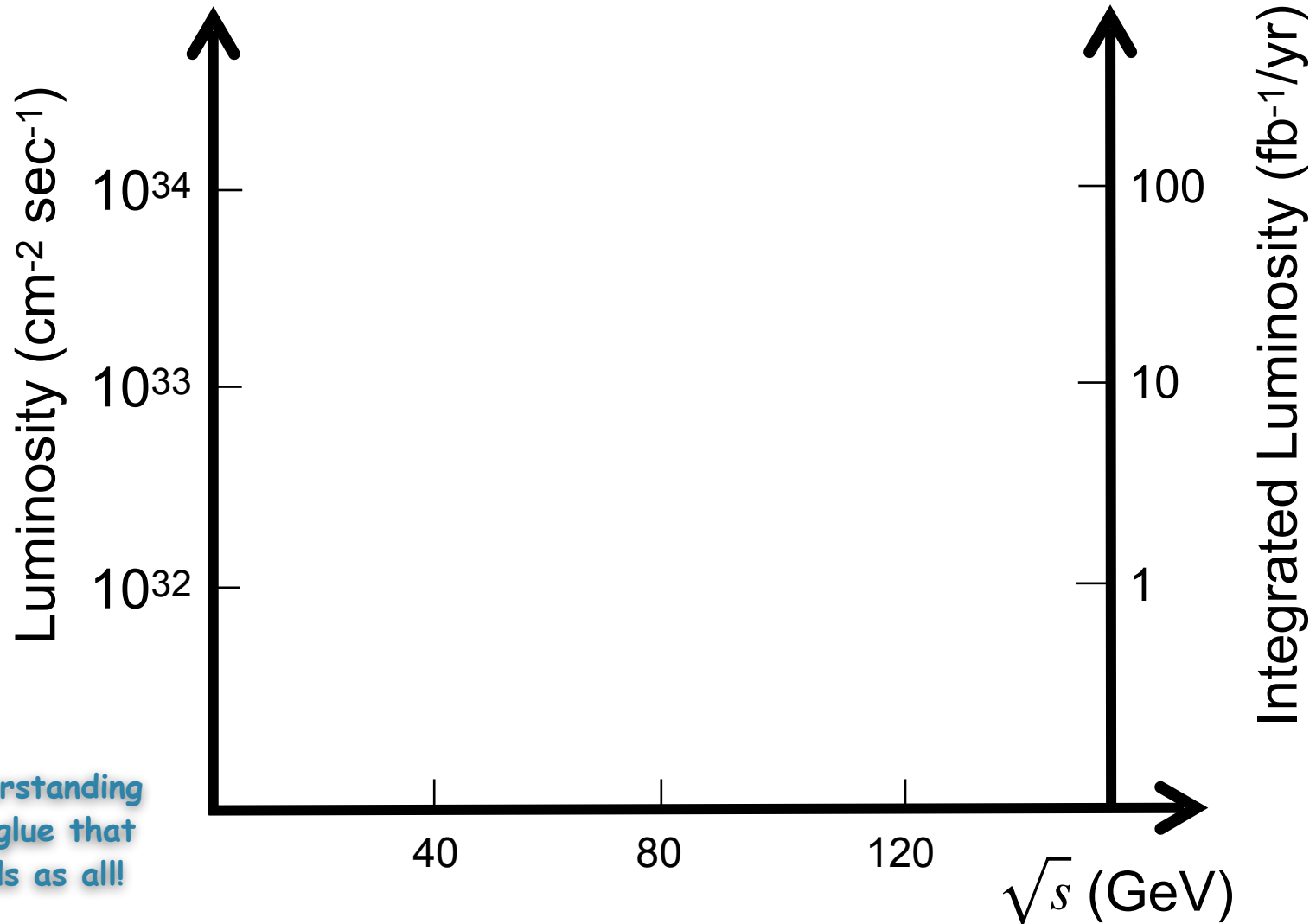

EIC Physics Pillars

- EIC: Study structure and dynamics of matter at **high luminosity**, **high energy** with **polarized beams** and **wide range of nuclei**

- Whitepaper:

[arXiv:1212.1701](https://arxiv.org/abs/1212.1701)

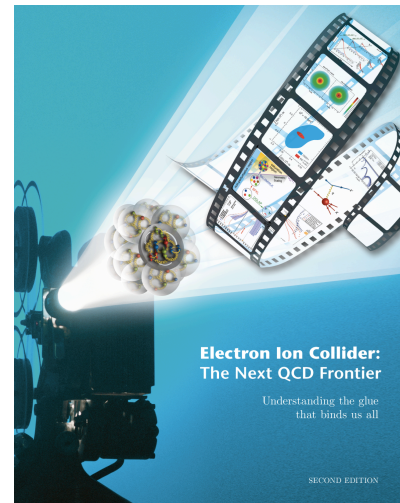

Understanding
the glue that
binds as all!

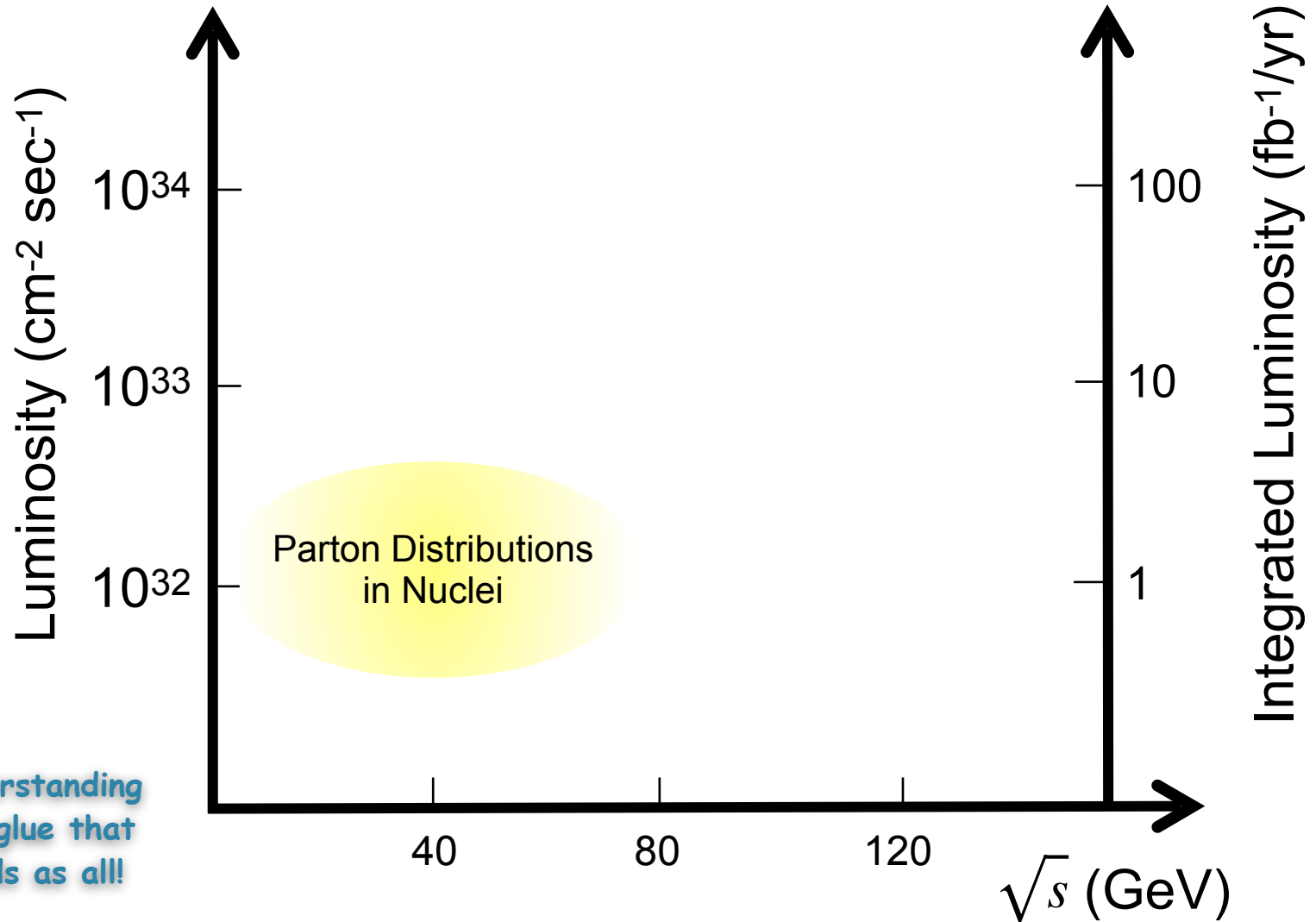

EIC Physics Pillars

- EIC: Study structure and dynamics of matter at **high luminosity**, **high energy** with **polarized beams** and **wide range of nuclei**

- Whitepaper:

arXiv:1212.1701

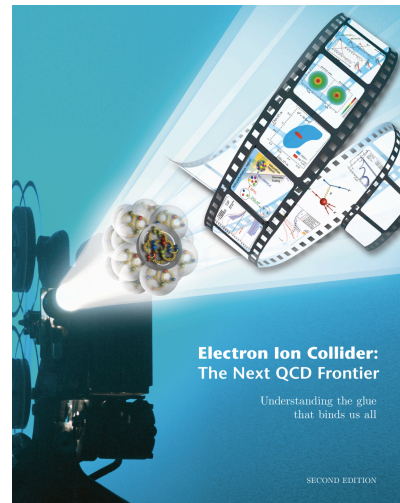

Understanding
the glue that
binds as all!

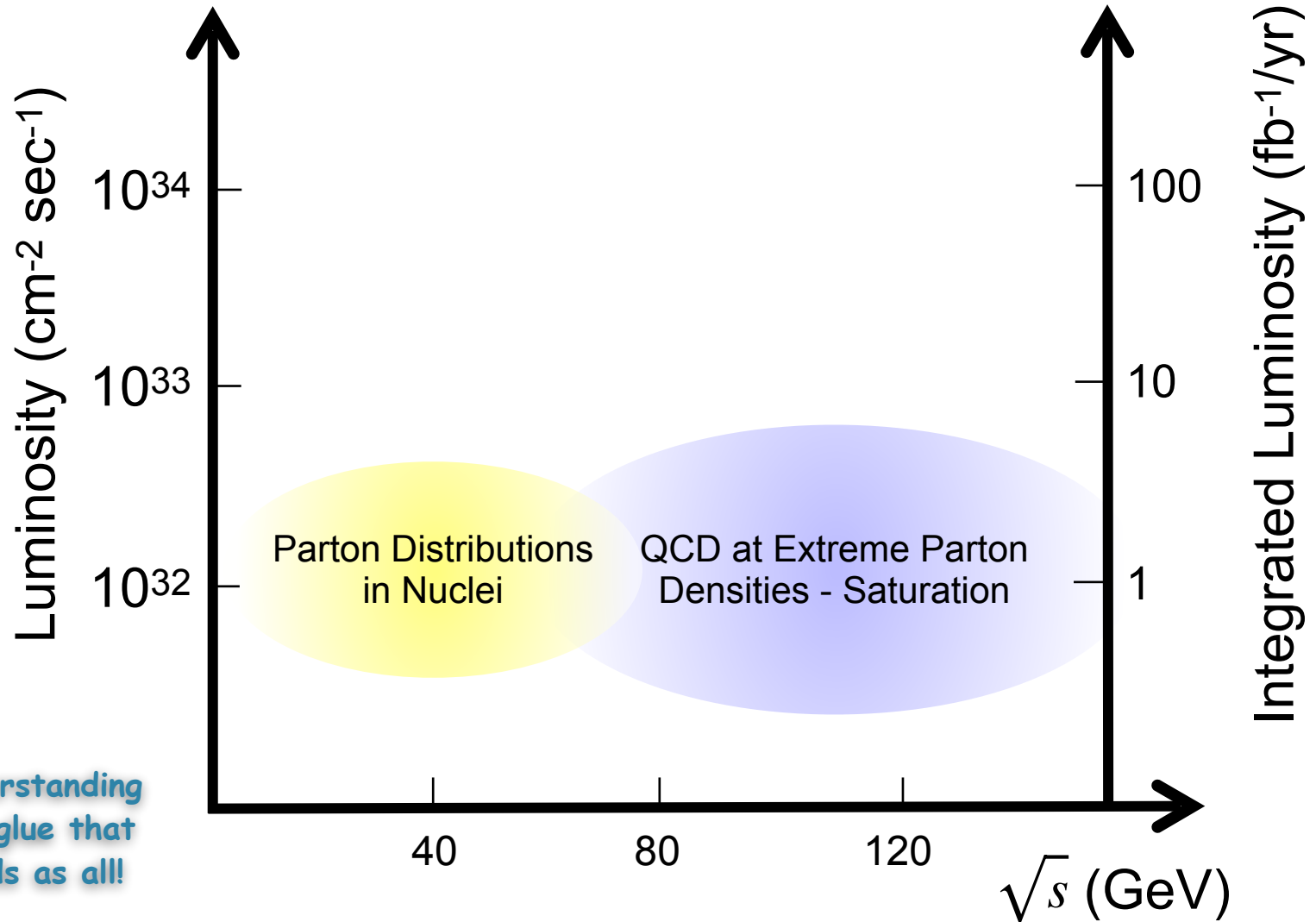

EIC Physics Pillars

- EIC: Study structure and dynamics of matter at **high luminosity**, **high energy** with **polarized beams** and **wide range of nuclei**

- Whitepaper:

arXiv:1212.1701

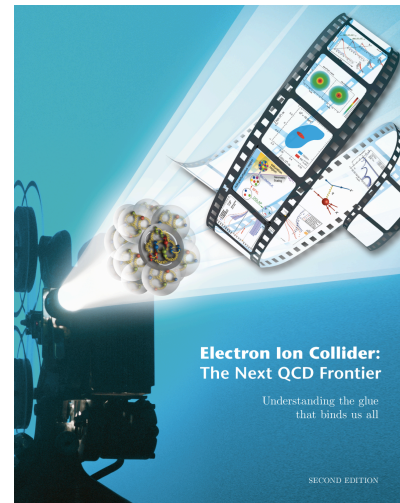

Understanding
the glue that
binds as all!

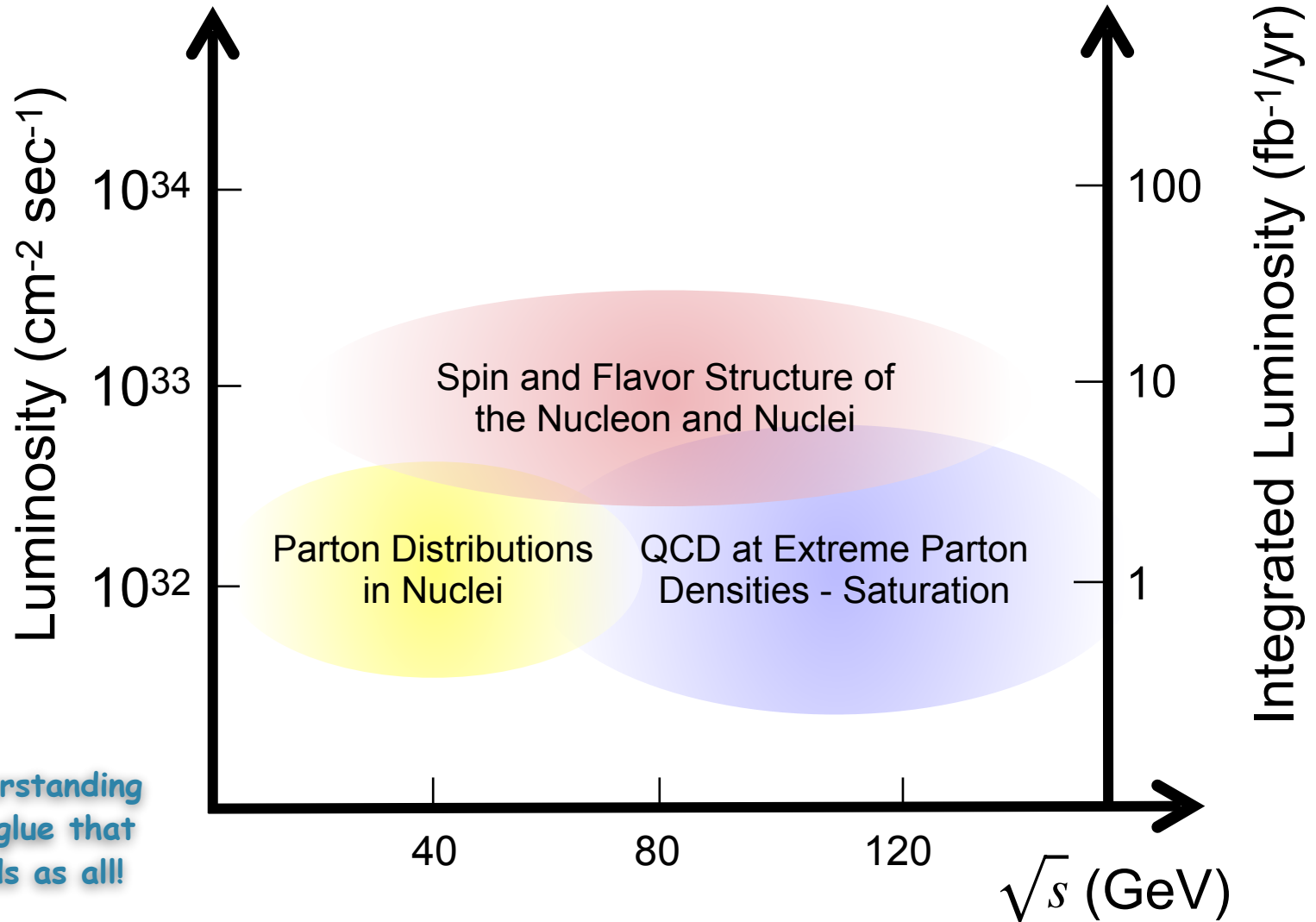

EIC Physics Pillars

- EIC: Study structure and dynamics of matter at **high luminosity**, **high energy** with **polarized beams** and **wide range of nuclei**

- Whitepaper:

arXiv:1212.1701

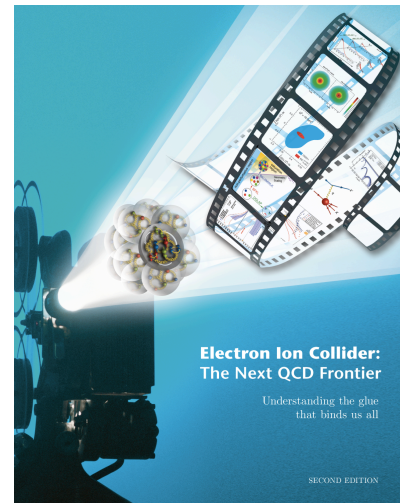

Understanding
the glue that
binds as all!

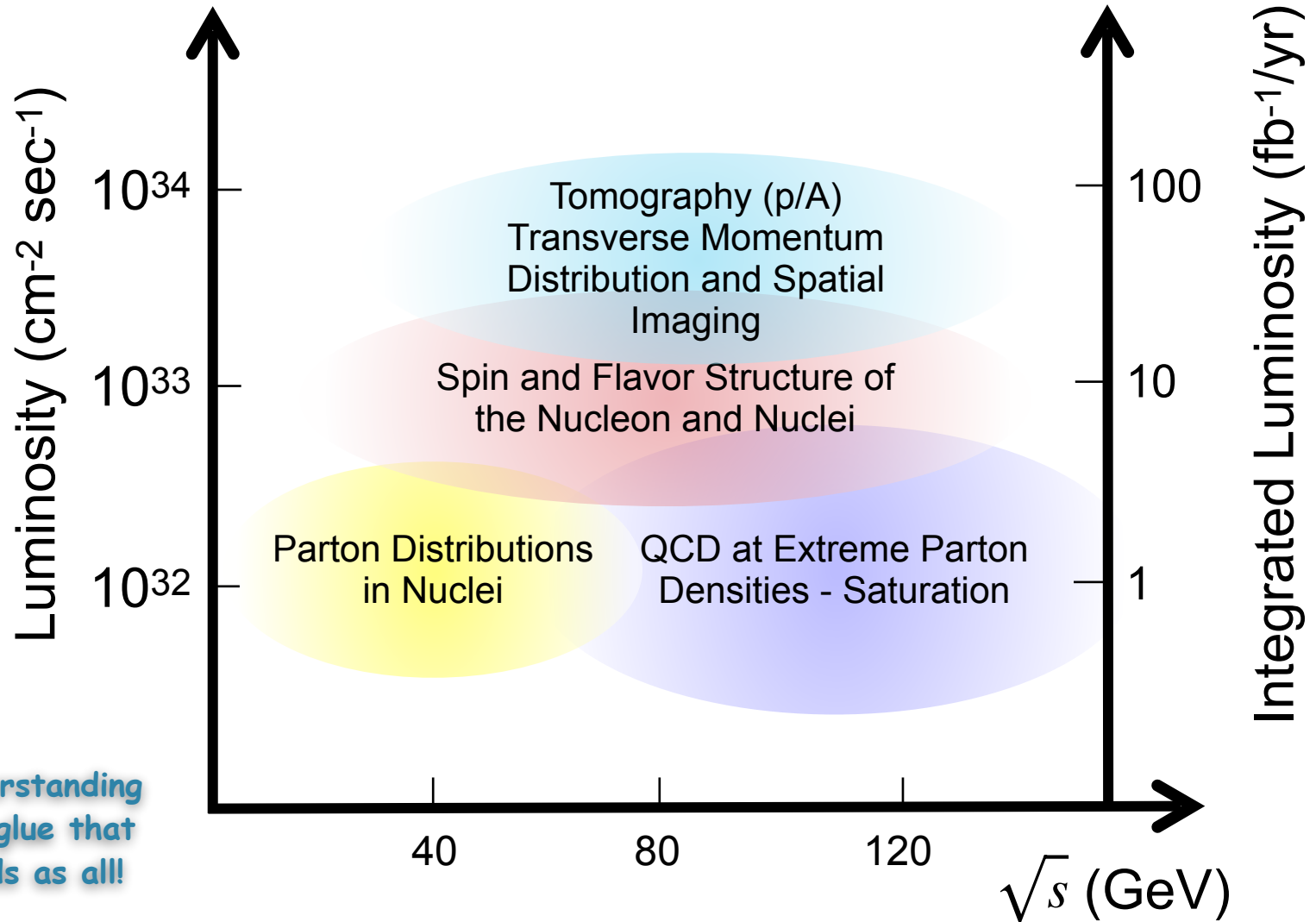

EIC Physics Pillars

□ Requirements

○ Machine:

- **High luminosity:** $10^{33}\text{cm}^{-2}\text{s}^{-1}$ - $10^{34}\text{cm}^{-2}\text{s}^{-1}$ / 10-100 $\text{fb}^{-1}/\text{year}$
- **Flexible center-of-mass energy** $\sqrt{s} = \sqrt{4 E_e E_p}$: **Wide kinematic range** $Q^2 = s x y$
- **Highly polarized** electron (0.7) and proton / light ion (0.7) **beams:** **Spin structure studies**
- **Wide range of nuclear beams** (d to Pb/U): **High gluon density**

○ Detector:

- **Wide acceptance** detector system including **particle ID** (e/h separation & π , K, p ID - flavor tagging)
- **Instrumentation for tagging of protons** from elastic reactions and neutrons from nuclear breakup: **Target / nuclear fragments** in addition to **low Q^2 tagger / polarimetry and luminosity (abs. and rel.) measurement**

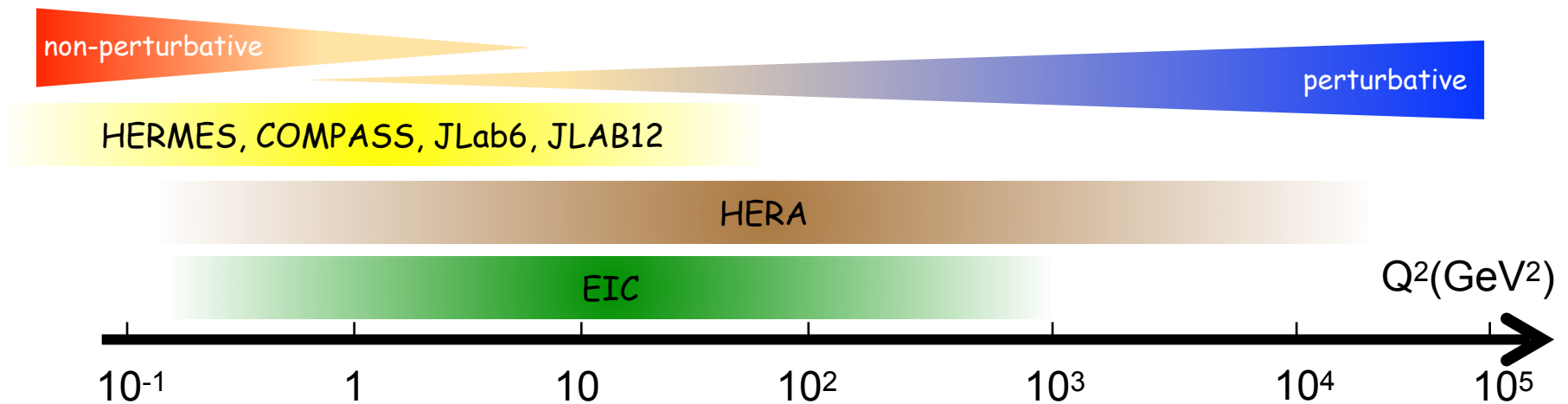



EIC Physics Pillars

- Luminosity / \sqrt{s} / Kinematic coverage

EIC Physics Pillars

- Luminosity / \sqrt{s} / Kinematic coverage

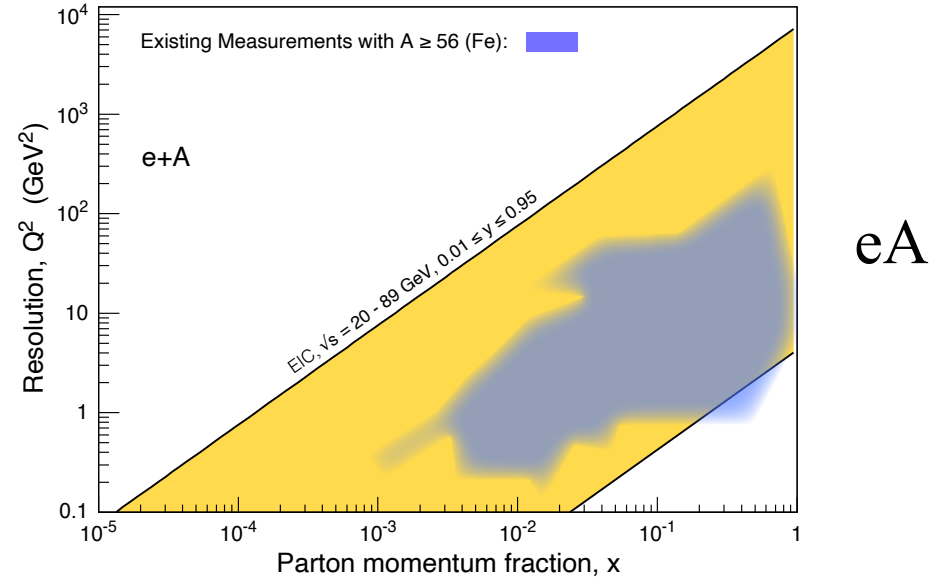

EIC Physics Pillars

- Luminosity / \sqrt{s} / Kinematic coverage

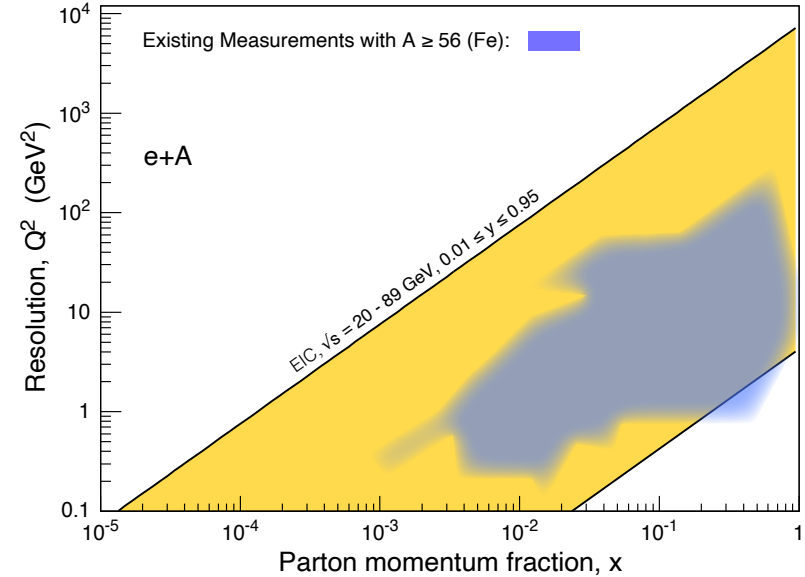

eA

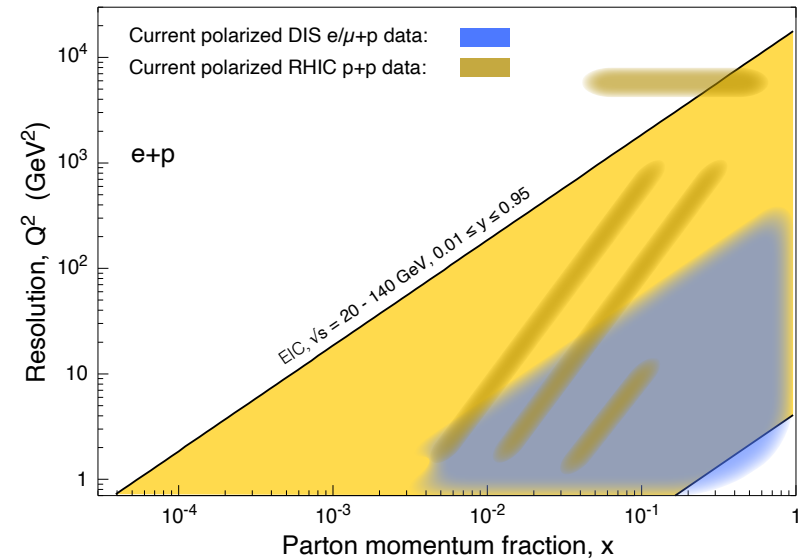

ep

EIC Physics Pillars

□ Luminosity / \sqrt{s} / Kinematic coverage

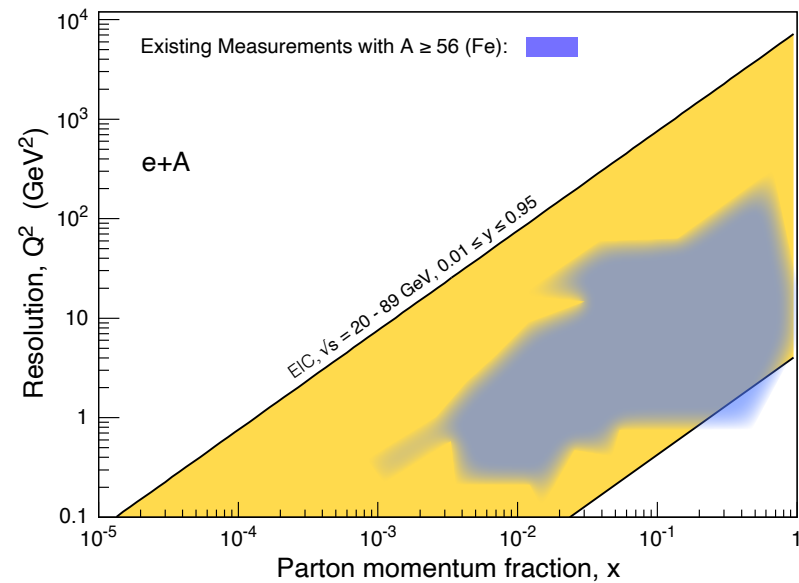
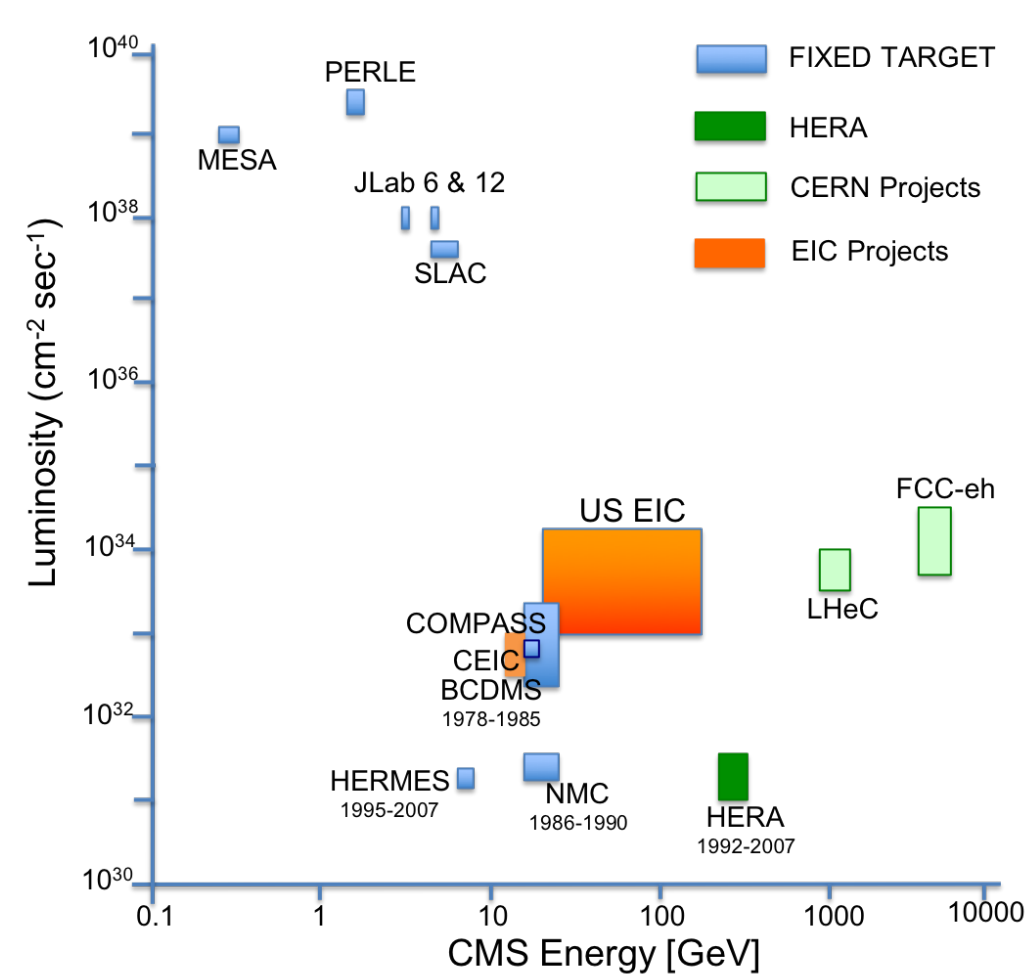

eA

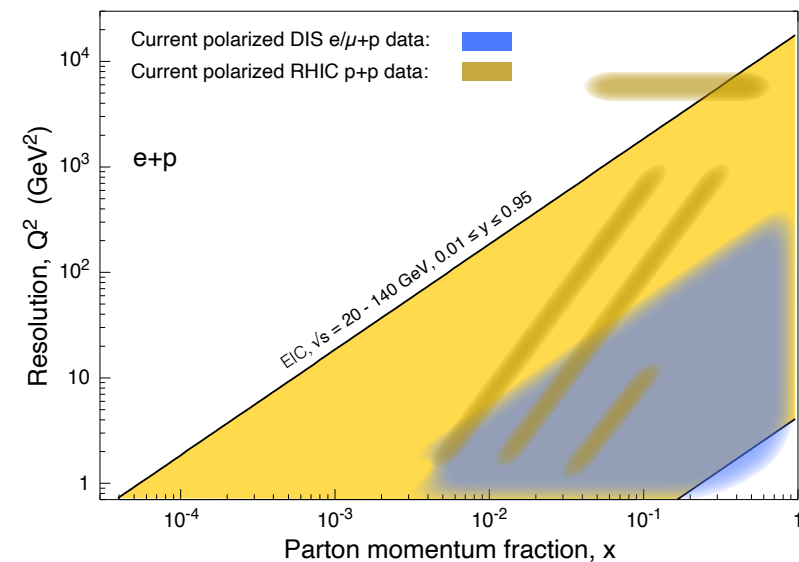

ep

EIC Physics Pillars

- DIS - Kinematics

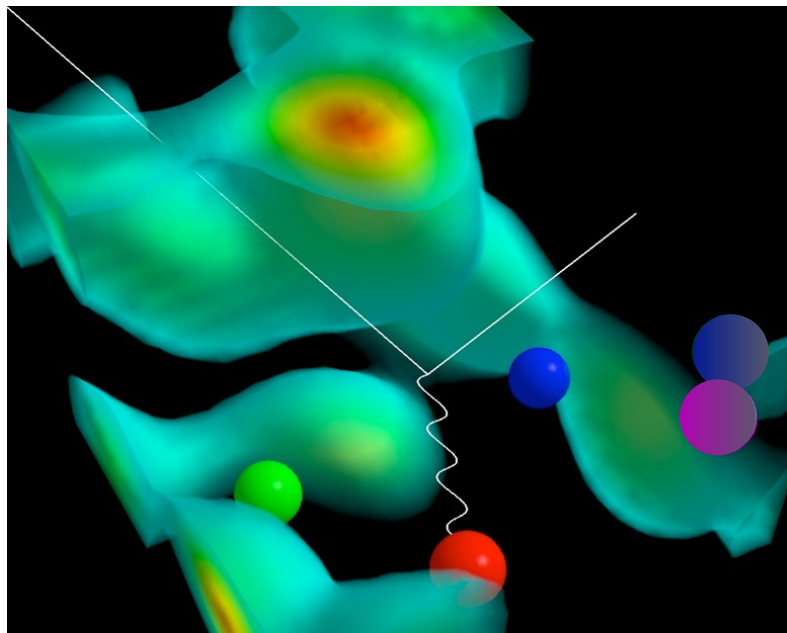

EIC Physics Pillars

DIS - Kinematics

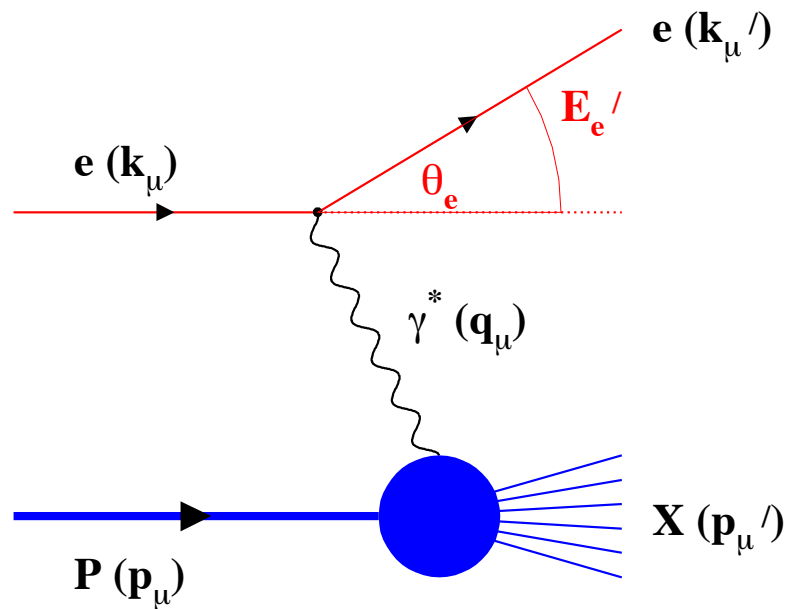

EIC Physics Pillars

DIS - Kinematics

$$k = \begin{pmatrix} E_e \\ 0 \\ 0 \\ -E_e \end{pmatrix}$$

$$p = \begin{pmatrix} E_P \\ 0 \\ 0 \\ E_P \end{pmatrix}$$

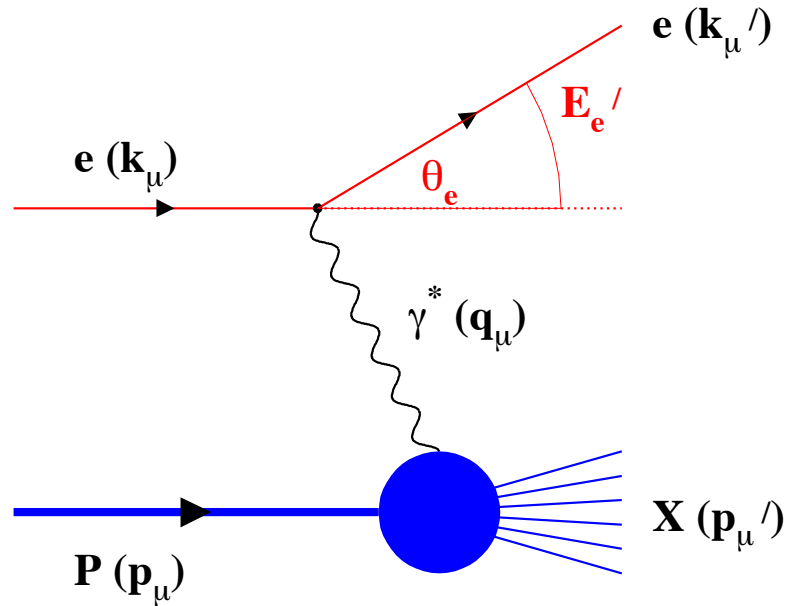

EIC Physics Pillars

DIS - Kinematics

$$k = \begin{pmatrix} E_e \\ 0 \\ 0 \\ -E_e \end{pmatrix}$$

$$p = \begin{pmatrix} E_P \\ 0 \\ 0 \\ E_P \end{pmatrix}$$

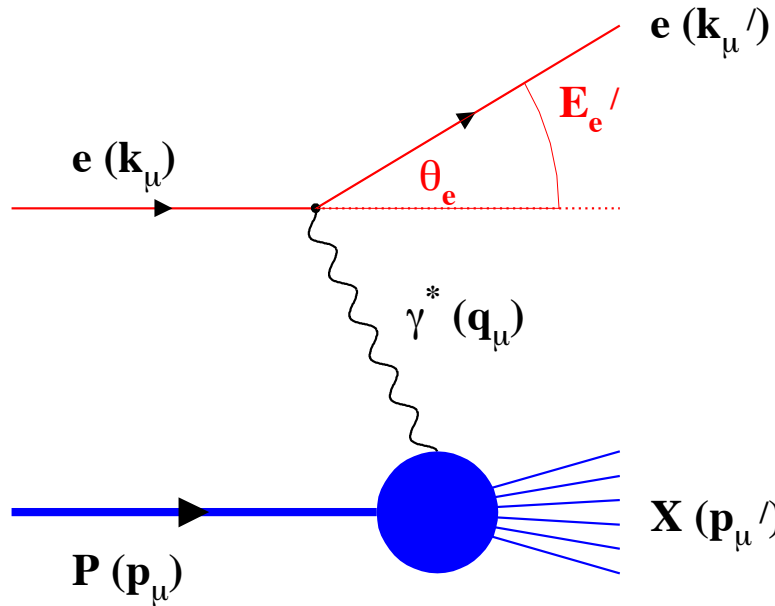

$$k' = \begin{pmatrix} E'_e \\ E'_e \sin \theta'_e \cos \phi'_e \\ E'_e \sin \theta'_e \sin \phi'_e \\ E'_e \cos \theta'_e \end{pmatrix}$$

$$p' = \begin{pmatrix} \sum_h E_h \\ \sum_h p_{X,h} \\ \sum_h p_{Y,h} \\ \sum_h p_{Z,h} \end{pmatrix}$$

EIC Physics Pillars

DIS - Kinematics

$$k = \begin{pmatrix} E_e \\ 0 \\ 0 \\ -E_e \end{pmatrix}$$

$$p = \begin{pmatrix} E_P \\ 0 \\ 0 \\ E_P \end{pmatrix}$$

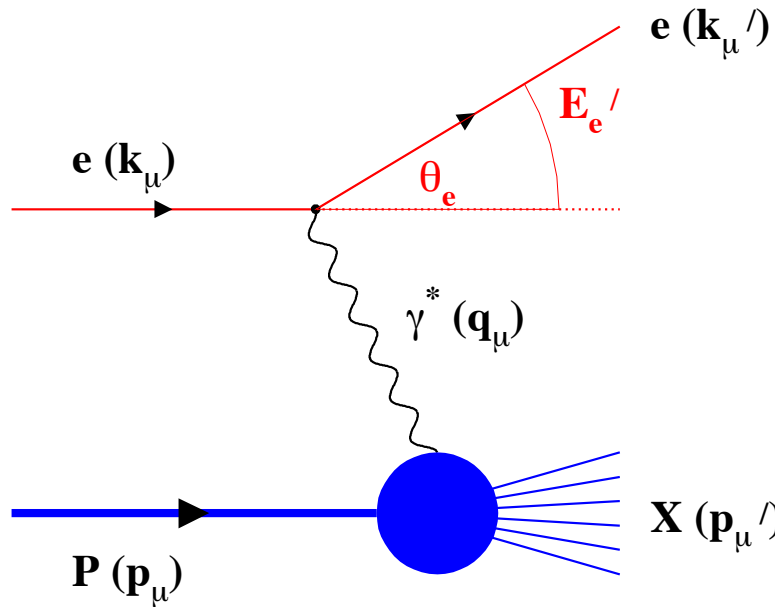

$$k' = \begin{pmatrix} E_e' \\ E_e' \sin \theta_e' \cos \phi_e' \\ E_e' \sin \theta_e' \sin \phi_e' \\ E_e' \cos \theta_e' \end{pmatrix}$$

$$p' = \begin{pmatrix} \sum_h E_h \\ \sum_h p_{X,h} \\ \sum_h p_{Y,h} \\ \sum_h p_{Z,h} \end{pmatrix}$$

$$Q^2 = -(k - k')^2 = -q^2$$

Measure of resolution power

$$x = \frac{Q^2}{2(p \cdot q)}$$

Measure of momentum fraction by struck quark

$$y = \frac{p \cdot q}{p \cdot k}$$

Measure of inelasticity

EIC Physics Pillars

DIS - Kinematics

$$k = \begin{pmatrix} E_e \\ 0 \\ 0 \\ -E_e \end{pmatrix}$$

$$p = \begin{pmatrix} E_P \\ 0 \\ 0 \\ E_P \end{pmatrix}$$

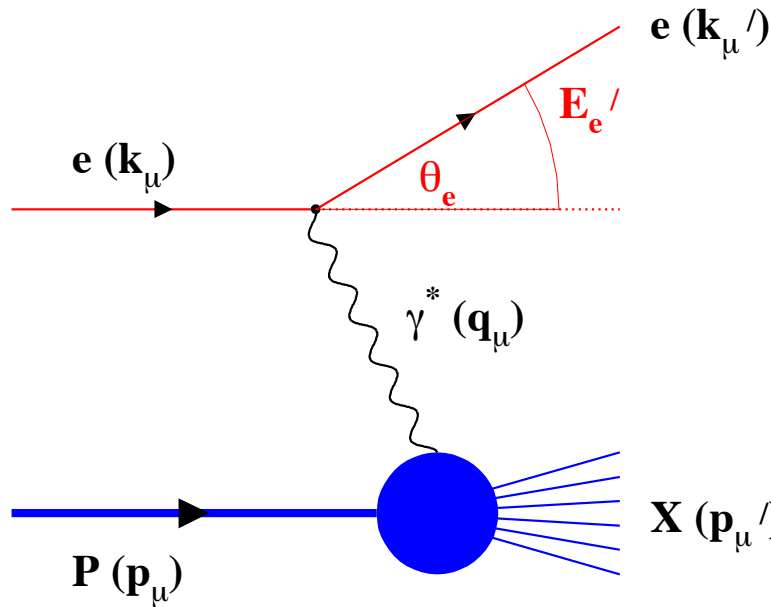

$$k' = \begin{pmatrix} E_e' \\ E_e' \sin \theta_e' \cos \phi_e' \\ E_e' \sin \theta_e' \sin \phi_e' \\ E_e' \cos \theta_e' \end{pmatrix}$$

$$p' = \begin{pmatrix} \sum_h E_h \\ \sum_h p_{X,h} \\ \sum_h p_{Y,h} \\ \sum_h p_{Z,h} \end{pmatrix}$$

$$Q^2 = -(k - k')^2 = -q^2$$

Measure of resolution power

$$x = \frac{Q^2}{2(p \cdot q)}$$

Measure of momentum fraction by struck quark

$$y = \frac{p \cdot q}{p \cdot k}$$

Measure of inelasticity

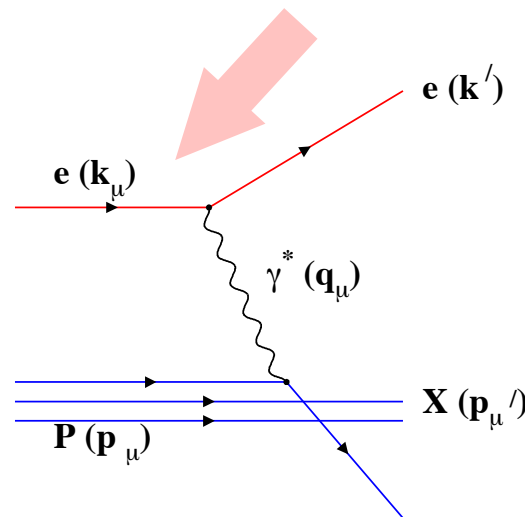

EIC Physics Pillars

DIS - Kinematics

$$k = \begin{pmatrix} E_e \\ 0 \\ 0 \\ -E_e \end{pmatrix}$$

$$p = \begin{pmatrix} E_P \\ 0 \\ 0 \\ E_P \end{pmatrix}$$

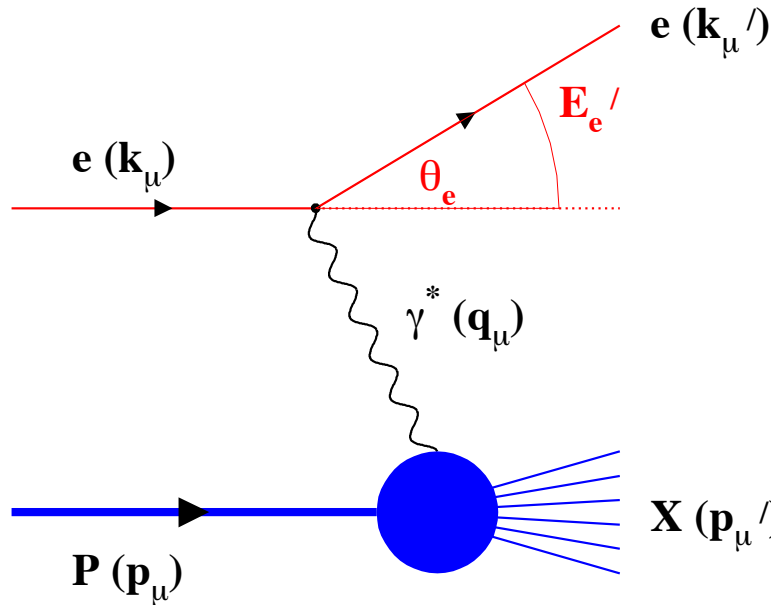

$$k' = \begin{pmatrix} E'_e \\ E'_e \sin \theta'_e \cos \phi'_e \\ E'_e \sin \theta'_e \sin \phi'_e \\ E'_e \cos \theta'_e \end{pmatrix}$$

$$p' = \begin{pmatrix} \sum_h E_h \\ \sum_h p_{X,h} \\ \sum_h p_{Y,h} \\ \sum_h p_{Z,h} \end{pmatrix}$$

$$Q^2 = -(k - k')^2 = -q^2$$

Measure of resolution power

$$x = \frac{Q^2}{2(p \cdot q)}$$

Measure of momentum fraction by struck quark

$$y = \frac{p \cdot q}{p \cdot k}$$

Measure of inelasticity

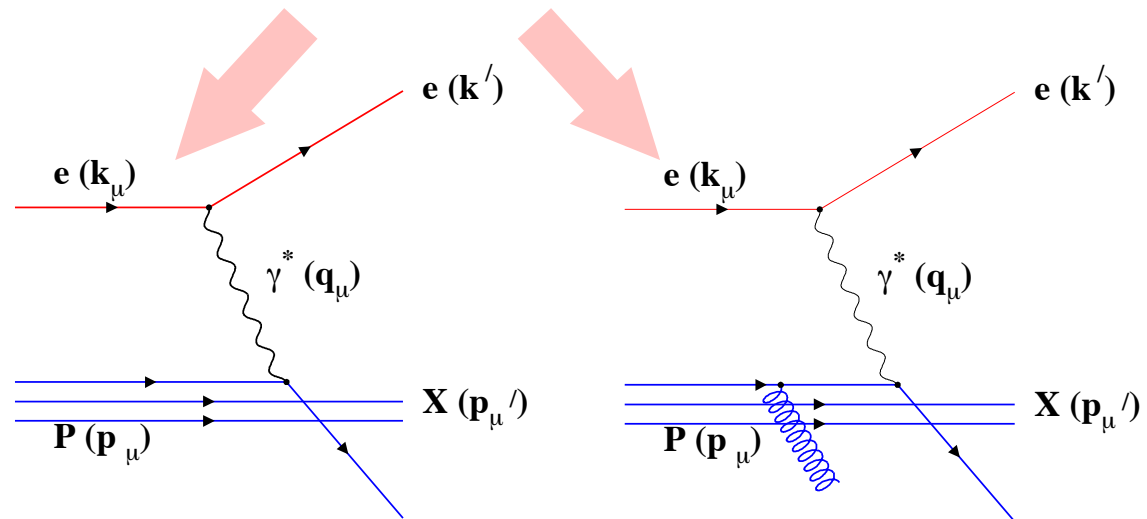



EIC Physics Pillars

- EIC kinematic considerations: $E_e=10\text{GeV}$ X $E_p=250\text{GeV}$ ($\sqrt{s}=100\text{GeV}$)



EIC Physics Pillars

- EIC kinematic considerations: $E_e=10\text{GeV}$ X $E_p=250\text{GeV}$ ($\sqrt{s}=100\text{GeV}$)

$$E_e = 10 \text{ GeV} \rightarrow$$



EIC Physics Pillars

- EIC kinematic considerations: $E_e=10\text{GeV}$ X $E_p=250\text{GeV}$ ($\sqrt{s}=100\text{GeV}$)

$$E_e = 10 \text{ GeV}$$



$$E_p = 250 \text{ GeV}$$



EIC Physics Pillars

- EIC kinematic considerations: $E_e=10\text{GeV}$ X $E_p=250\text{GeV}$ ($\sqrt{s}=100\text{GeV}$)

$E_e = 10\text{ GeV}$

$E_p = 250\text{ GeV}$

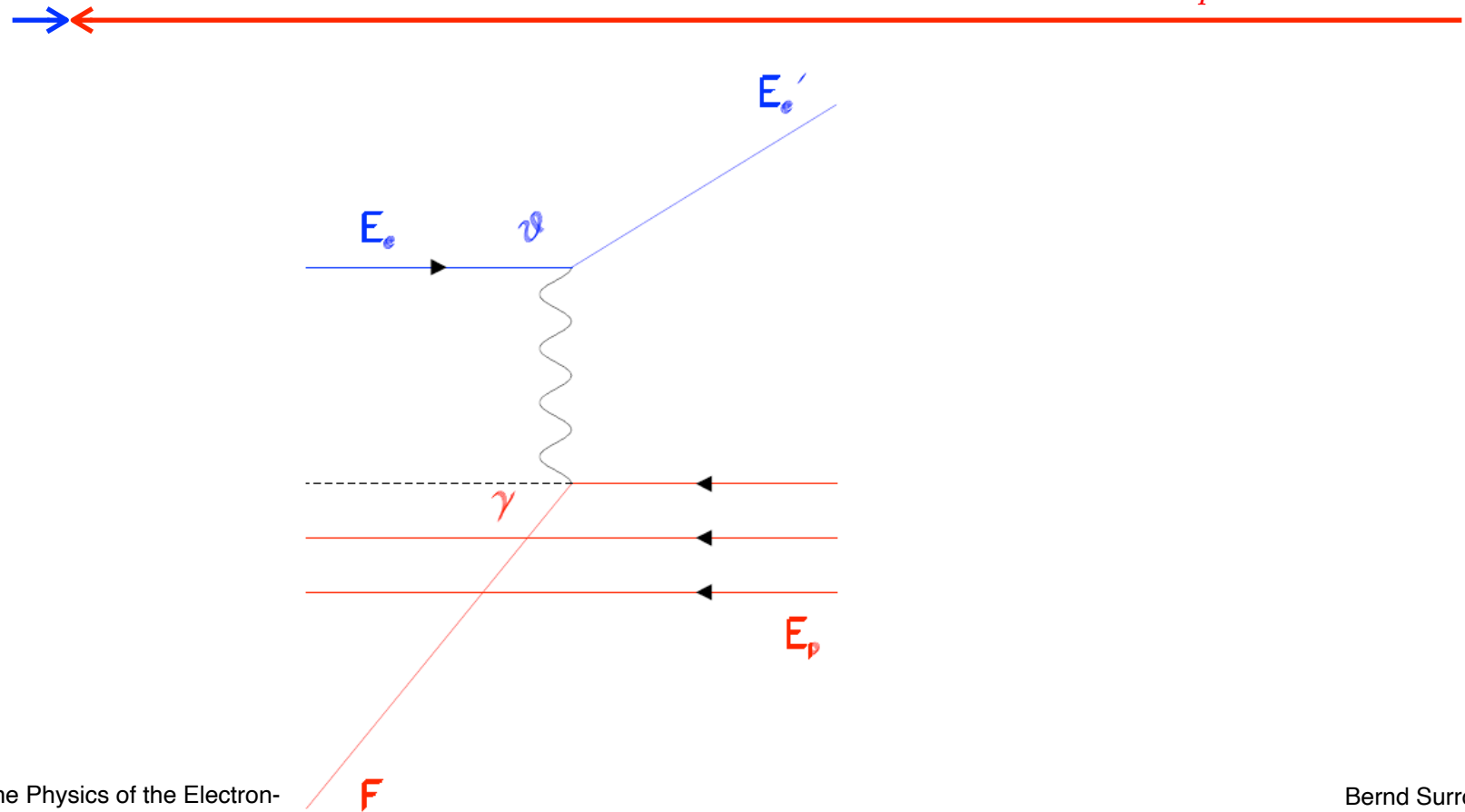

EIC Physics Pillars

- EIC kinematic considerations: $E_e = 10 \text{ GeV}$ X $E_p = 250 \text{ GeV}$ ($\sqrt{s} = 100 \text{ GeV}$)

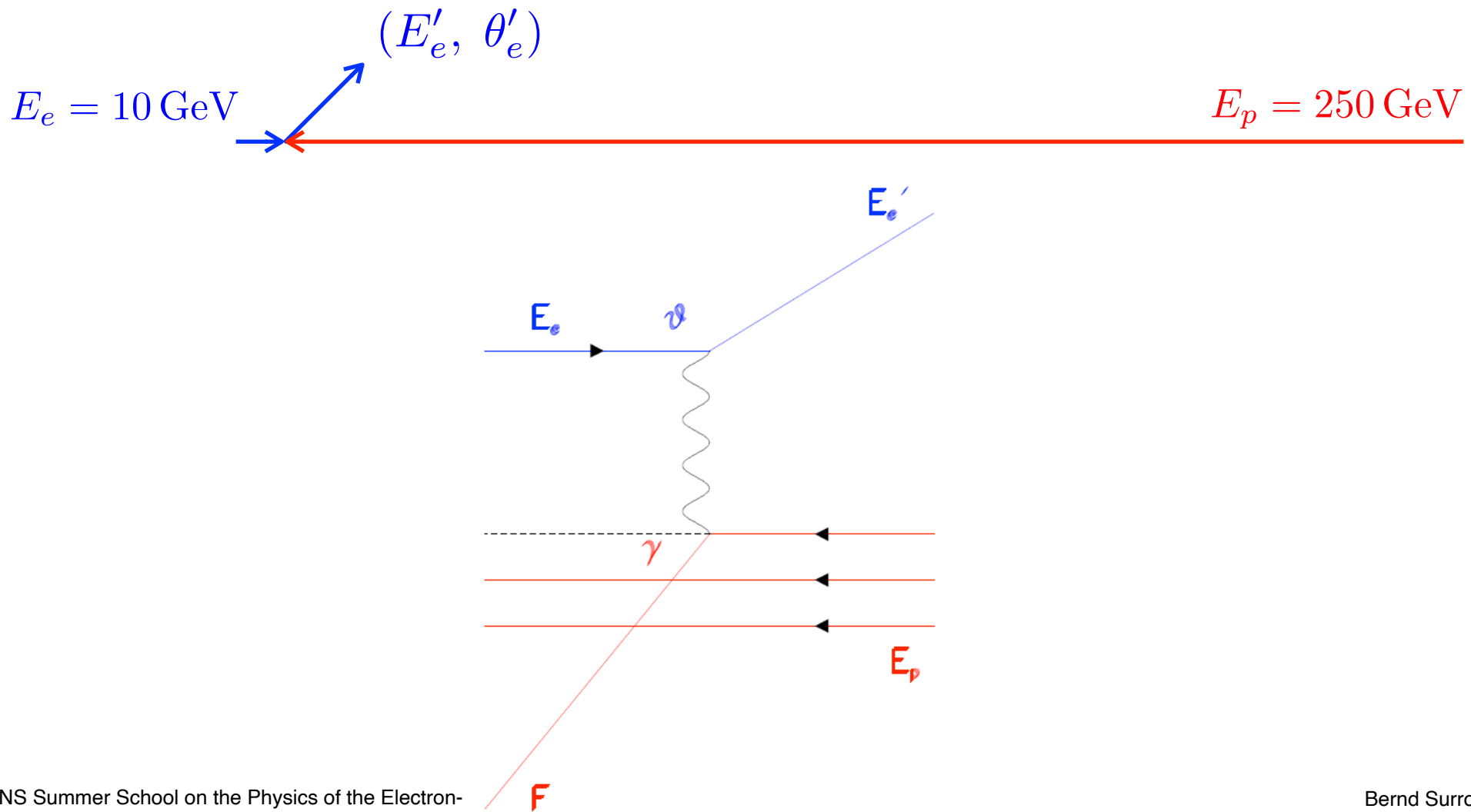

EIC Physics Pillars

- EIC kinematic considerations: $E_e=10\text{GeV}$ X $E_p=250\text{GeV}$ ($\sqrt{s}=100\text{GeV}$)

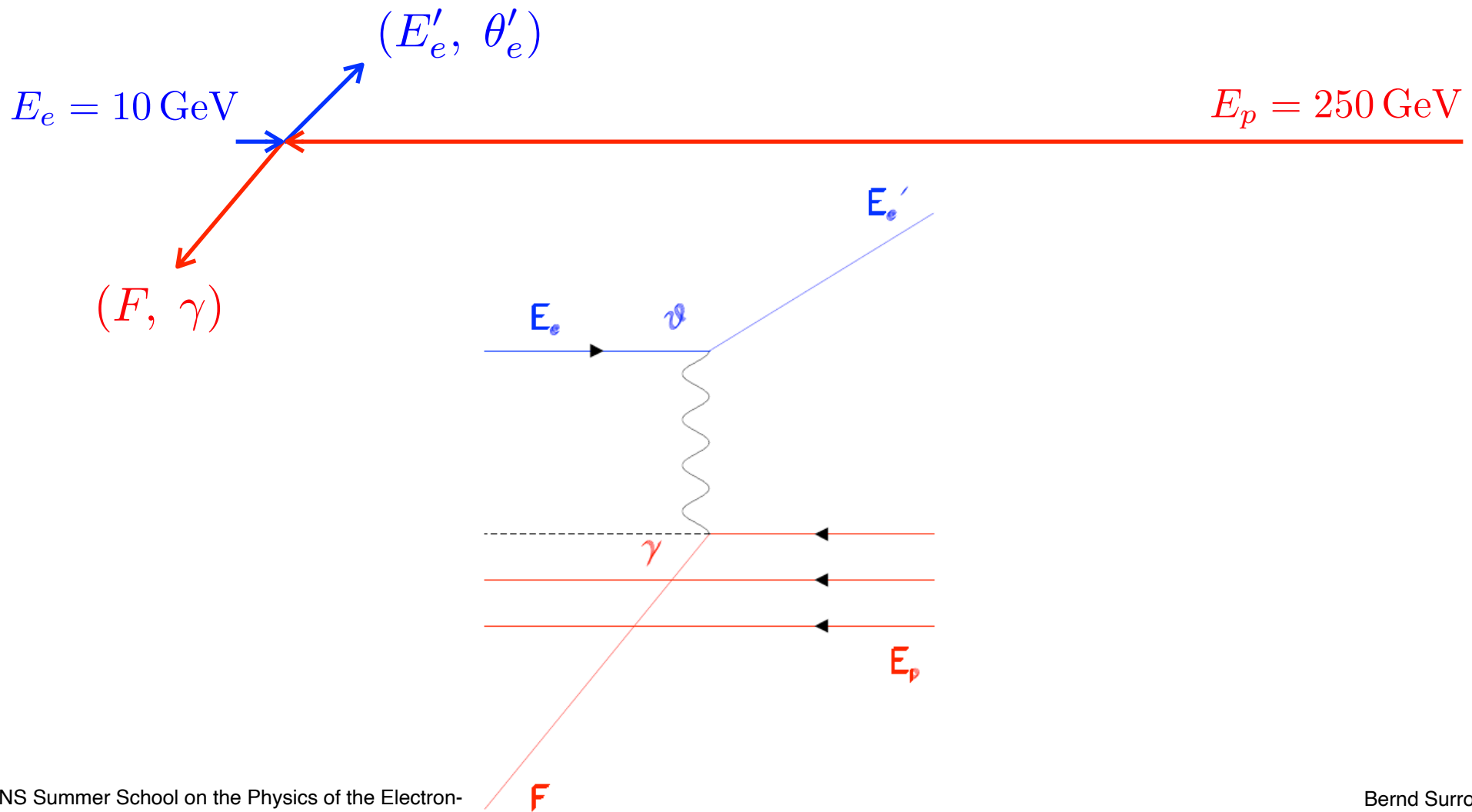



EIC Physics Pillars

- EIC kinematic considerations: $E_e=10\text{GeV}$ X $E_p=250\text{GeV}$ ($\sqrt{s}=100\text{GeV}$)

EIC Physics Pillars

- EIC kinematic considerations: $E_e=10\text{GeV}$ X $E_n=250\text{GeV}$ ($\sqrt{s}=100\text{GeV}$)

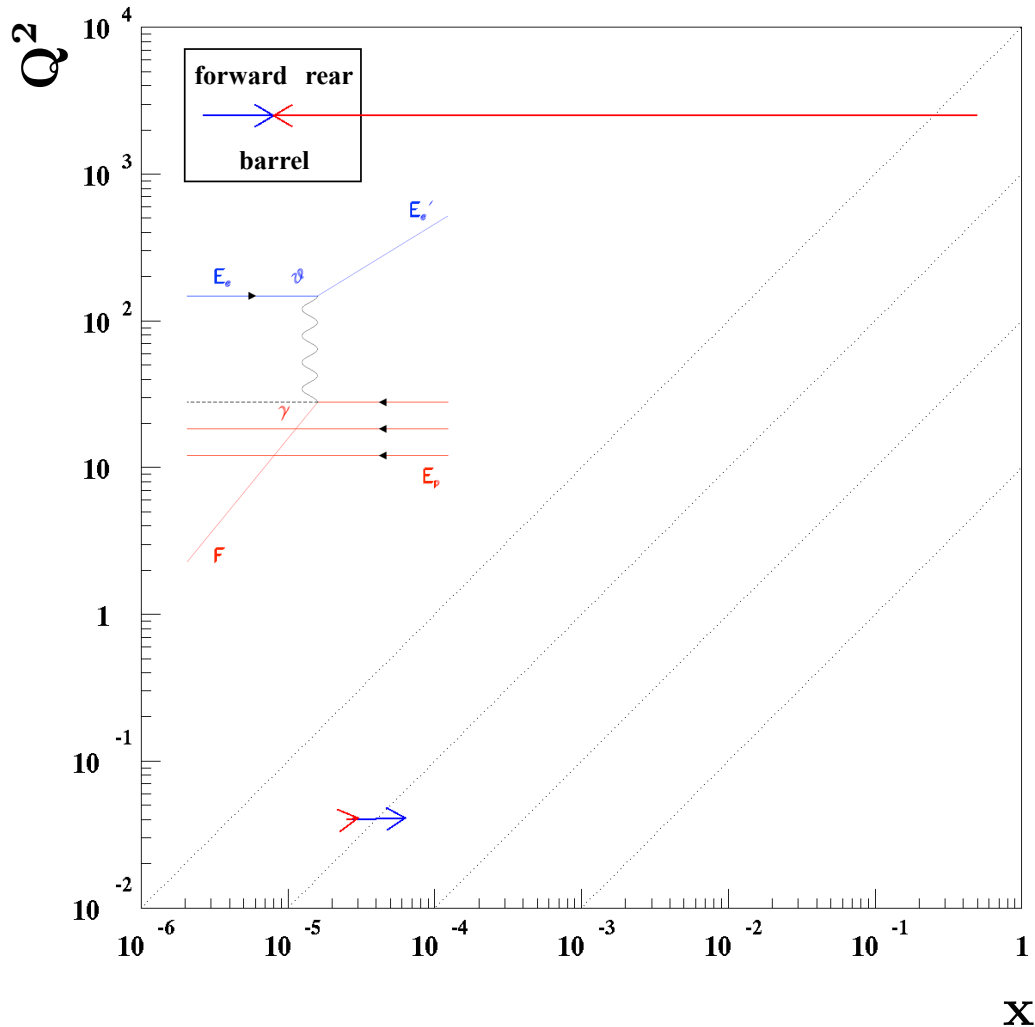

■

EIC Physics Pillars

- EIC kinematic considerations: $E_e=10\text{GeV}$ X $E_n=250\text{GeV}$ ($\sqrt{s}=100\text{GeV}$)

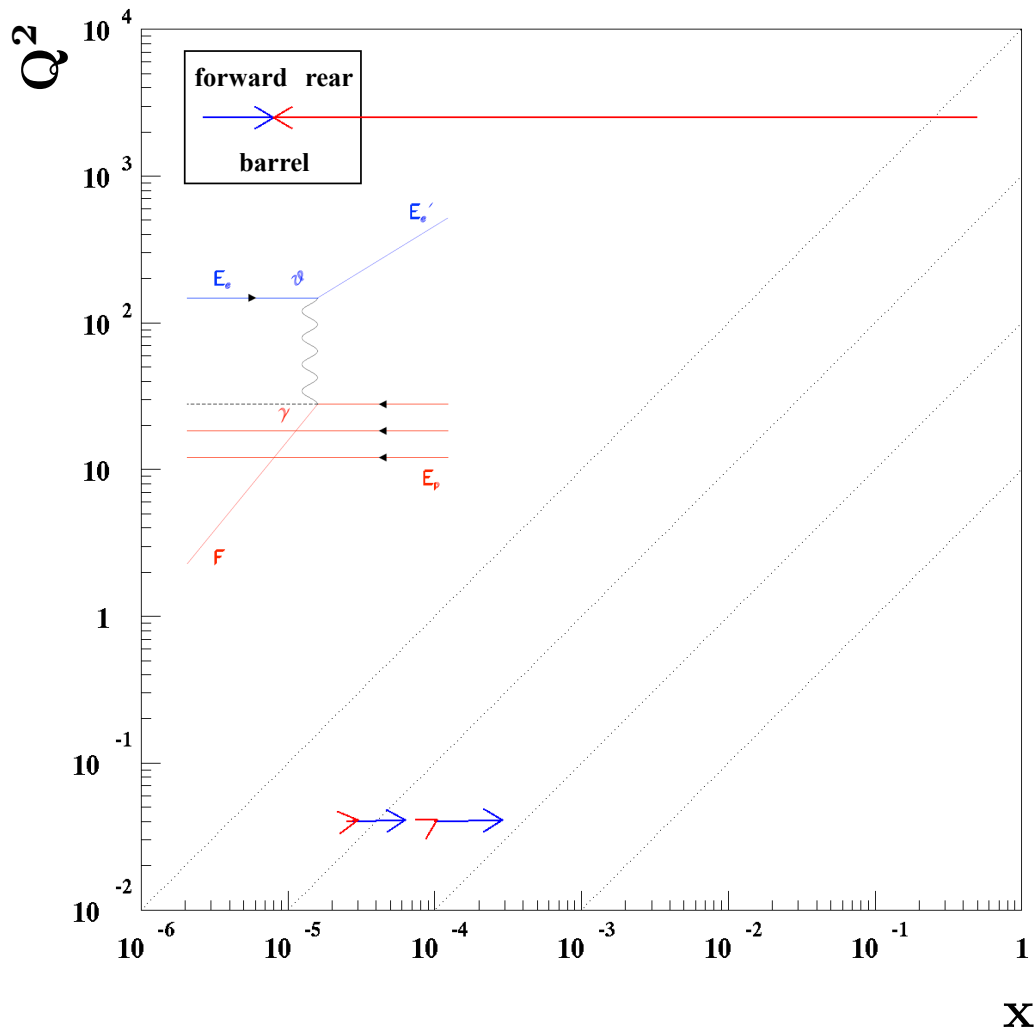

EIC Physics Pillars

- EIC kinematic considerations: $E_e=10\text{GeV}$ X $E_n=250\text{GeV}$ ($\sqrt{s}=100\text{GeV}$)

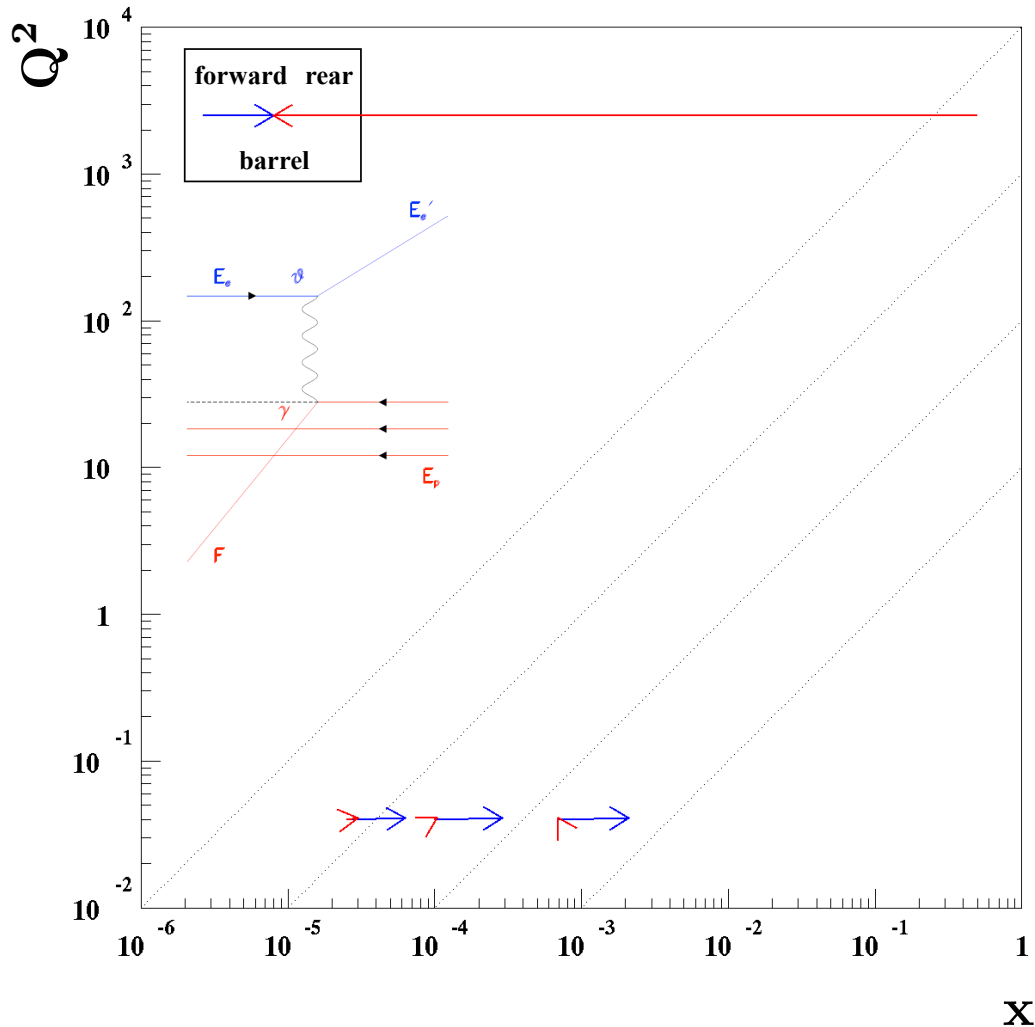

■

EIC Physics Pillars

- EIC kinematic considerations: $E_e=10\text{GeV}$ X $E_n=250\text{GeV}$ ($\sqrt{s}=100\text{GeV}$)

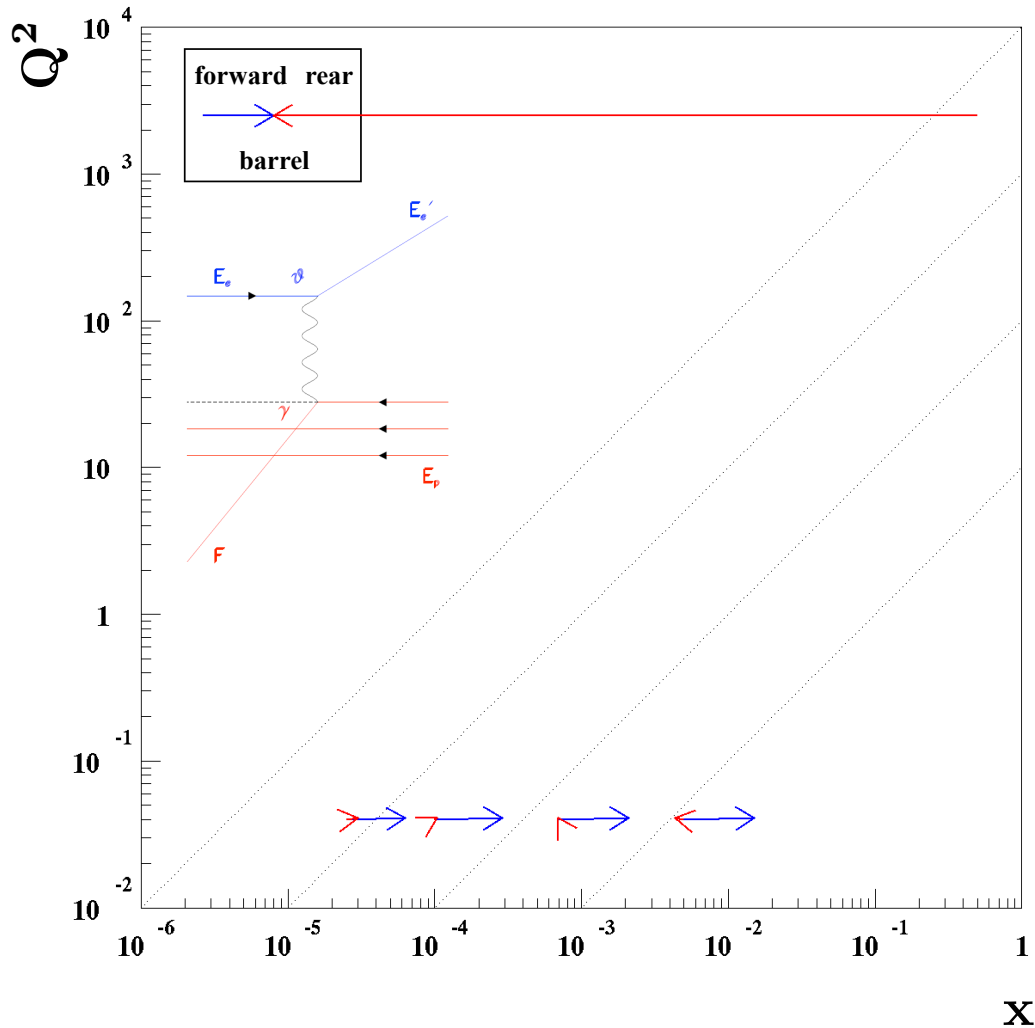

EIC Physics Pillars

- EIC kinematic considerations: $E_e=10\text{GeV}$ X $E_n=250\text{GeV}$ ($\sqrt{s}=100\text{GeV}$)

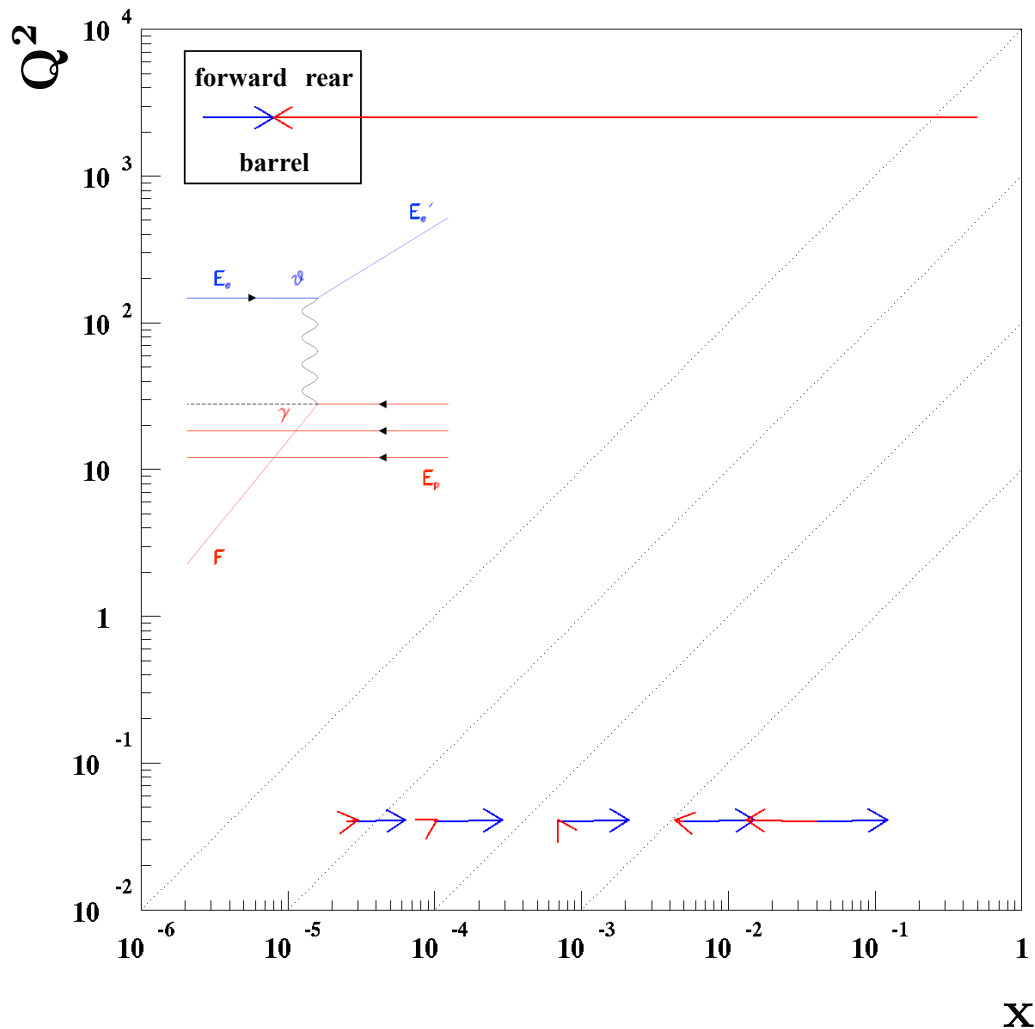

EIC Physics Pillars

- EIC kinematic considerations: $E_e=10\text{GeV}$ X $E_n=250\text{GeV}$ ($\sqrt{s}=100\text{GeV}$)

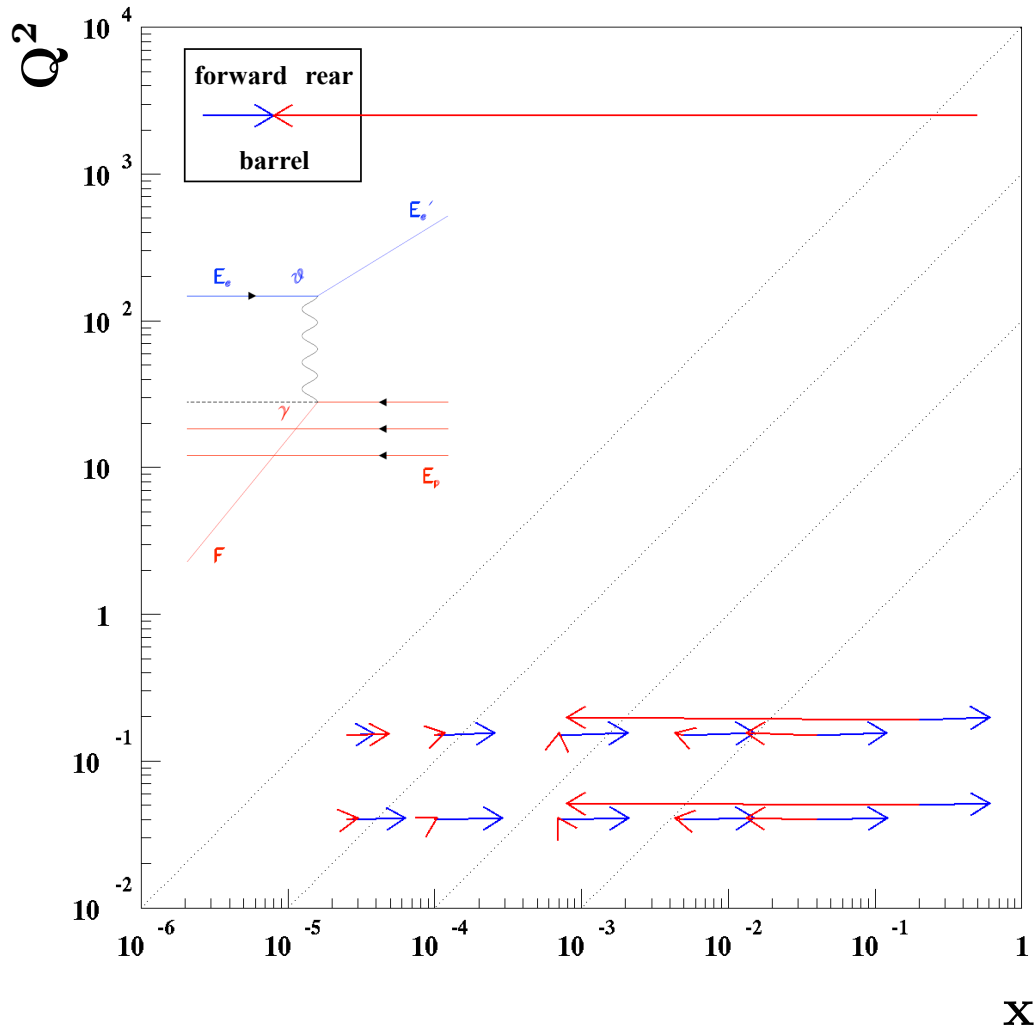

EIC Physics Pillars

- EIC kinematic considerations: $E_e=10\text{GeV}$ X $E_n=250\text{GeV}$ ($\sqrt{s}=100\text{GeV}$)

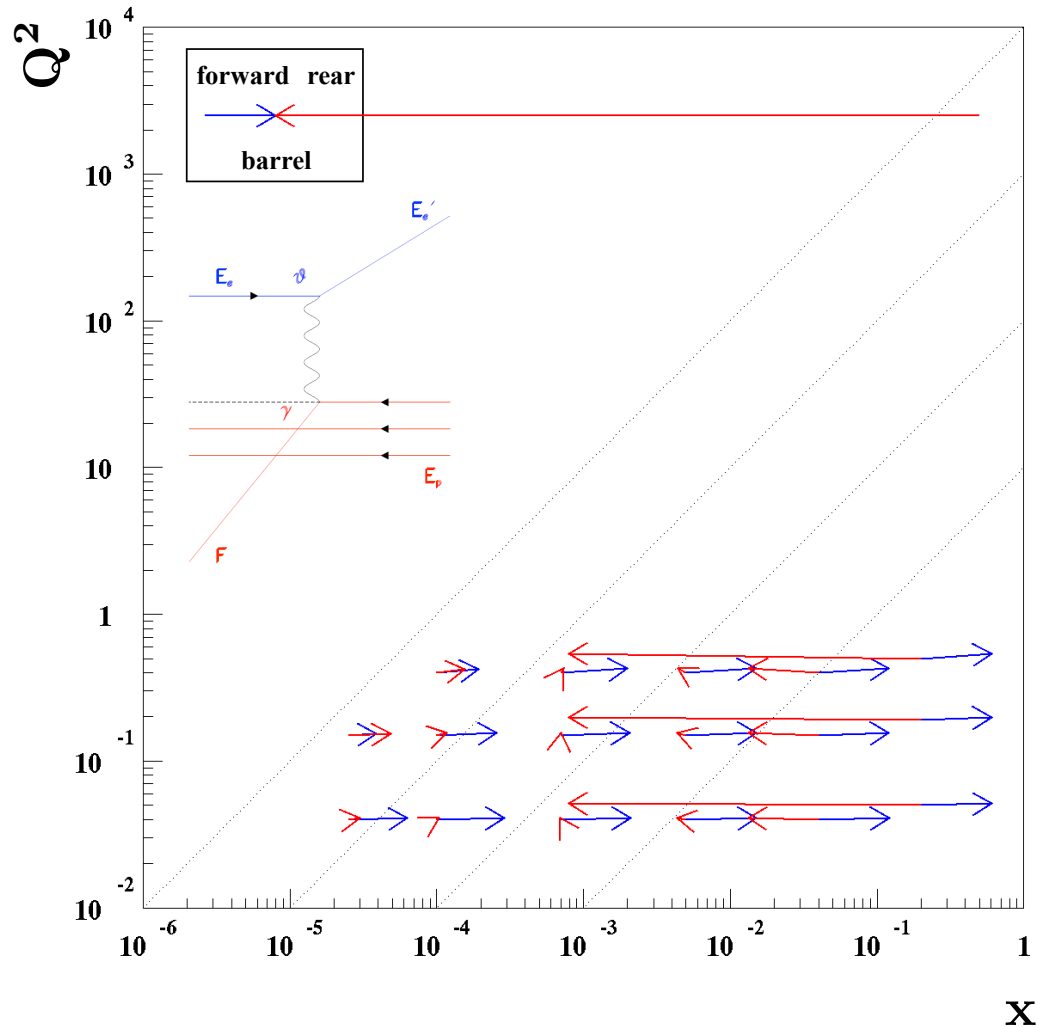



EIC Physics Pillars

- EIC kinematic considerations: $E_e=10\text{GeV}$ X $E_n=250\text{GeV}$ ($\sqrt{s}=100\text{GeV}$)

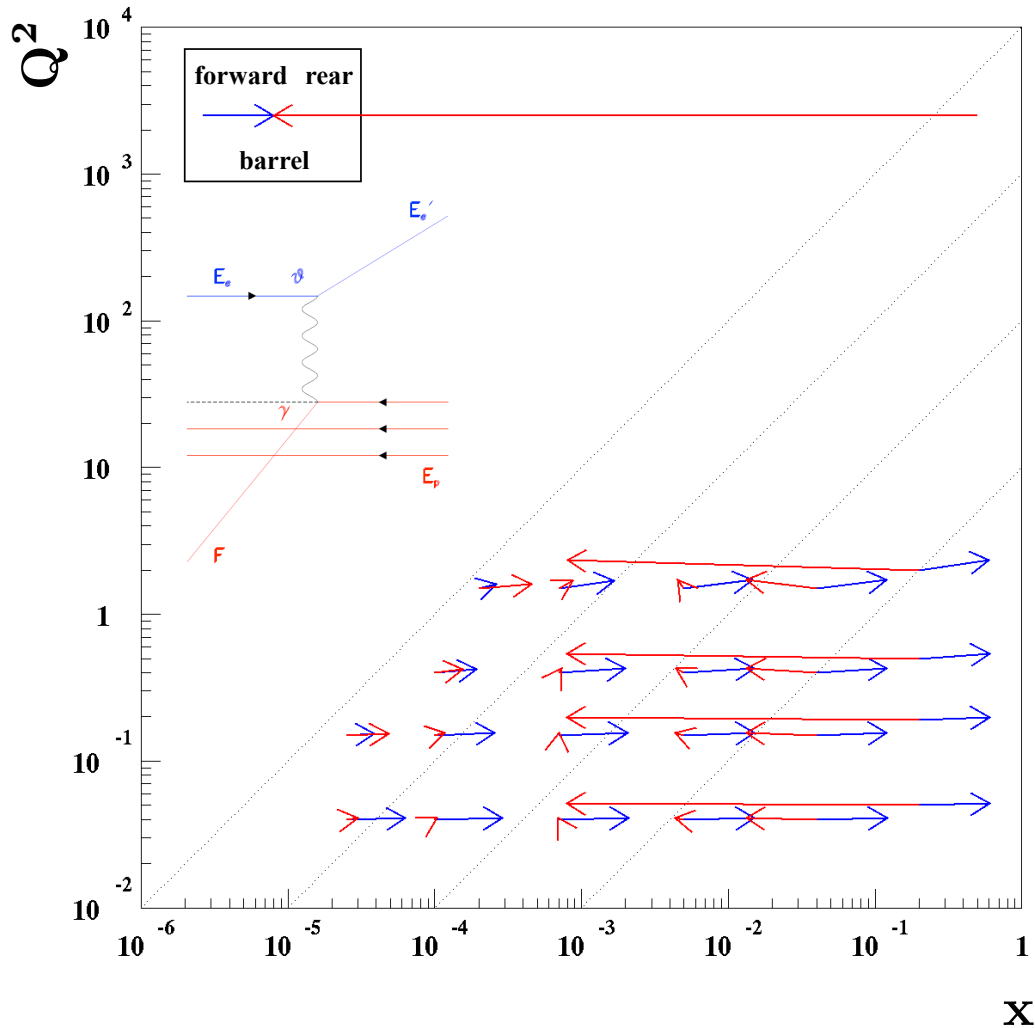

EIC Physics Pillars

- EIC kinematic considerations: $E_e=10\text{GeV}$ X $E_n=250\text{GeV}$ ($\sqrt{s}=100\text{GeV}$)

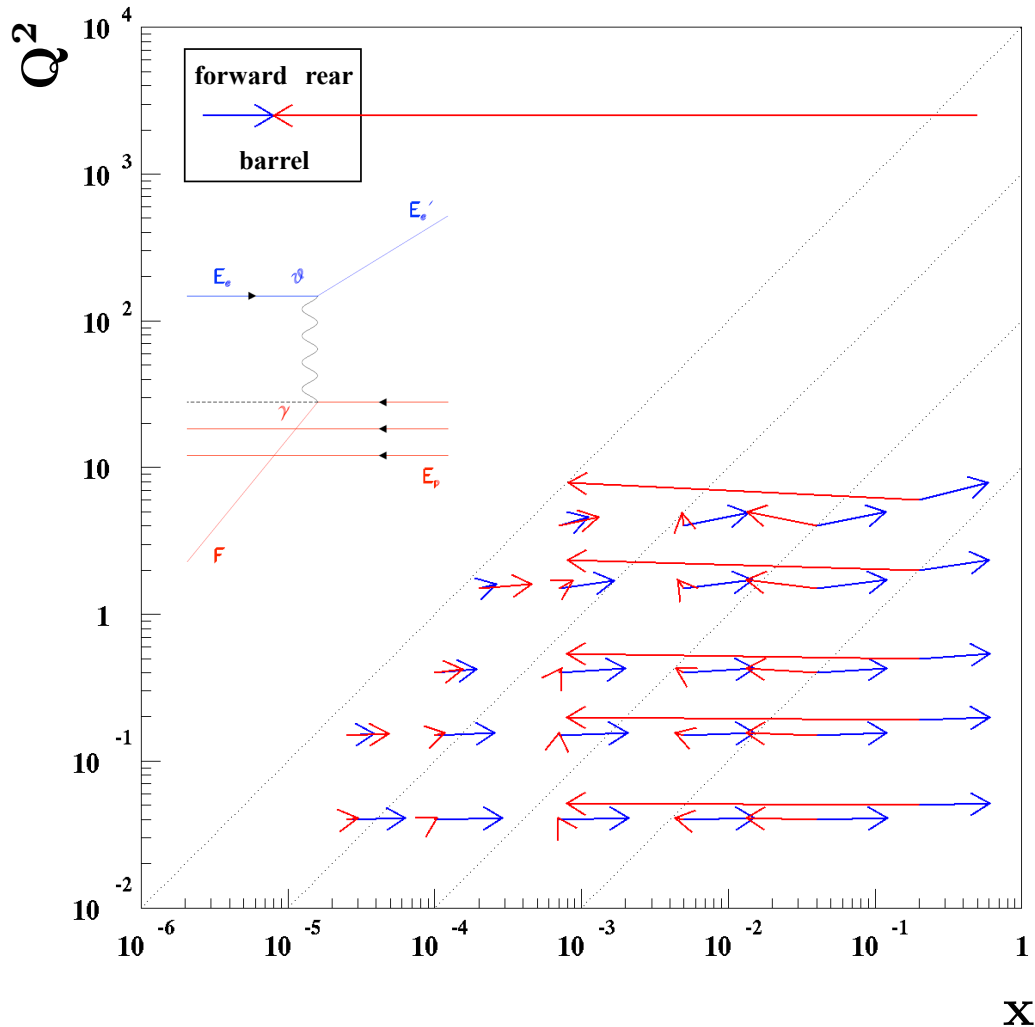

■

EIC Physics Pillars

- EIC kinematic considerations: $E_e=10\text{GeV}$ X $E_n=250\text{GeV}$ ($\sqrt{s}=100\text{GeV}$)

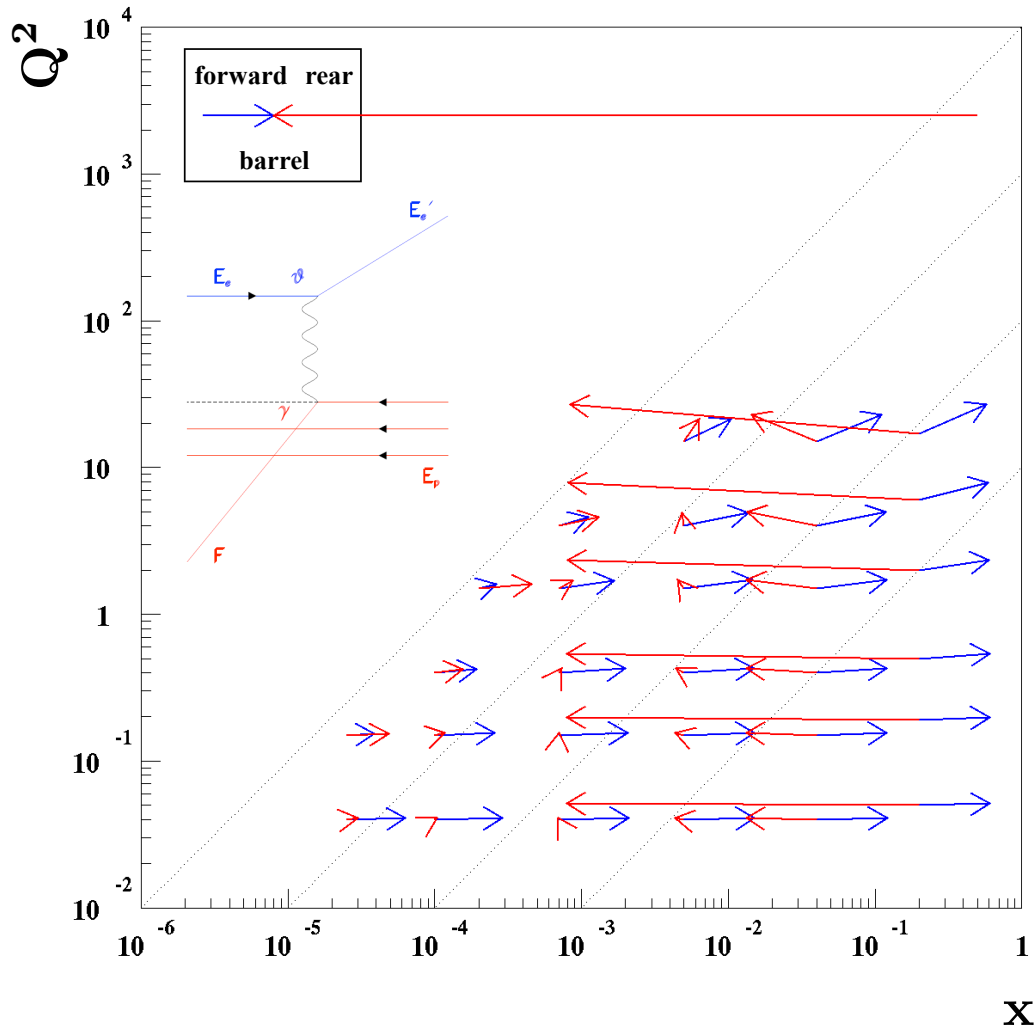

■



EIC Physics Pillars

- EIC kinematic considerations: $E_e=10\text{GeV}$ X $E_n=250\text{GeV}$ ($\sqrt{s}=100\text{GeV}$)

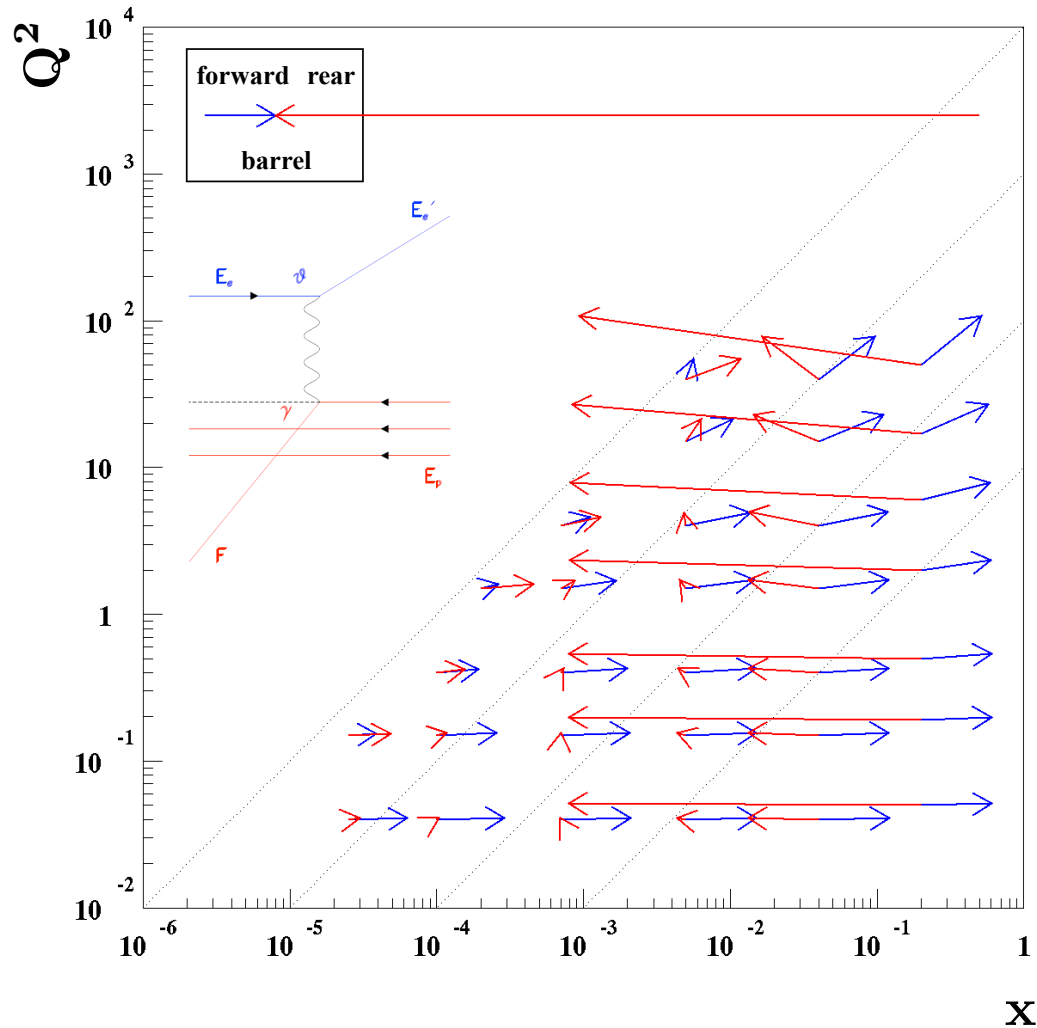

EIC Physics Pillars

- EIC kinematic considerations: $E_e=10\text{GeV}$ X $E_n=250\text{GeV}$ ($\sqrt{s}=100\text{GeV}$)

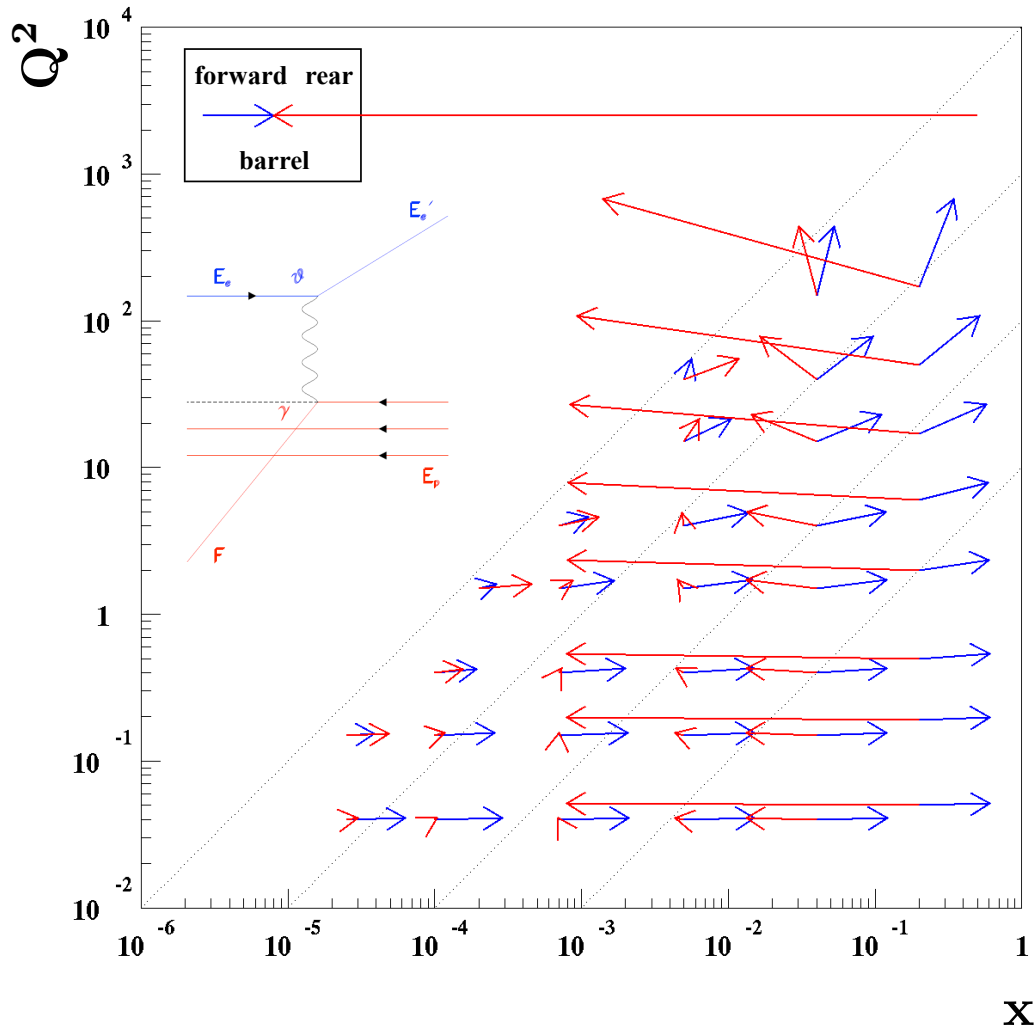

■

EIC Physics Pillars

- EIC kinematic considerations: $E_e=10\text{GeV}$ X $E_n=250\text{GeV}$ ($\sqrt{s}=100\text{GeV}$)

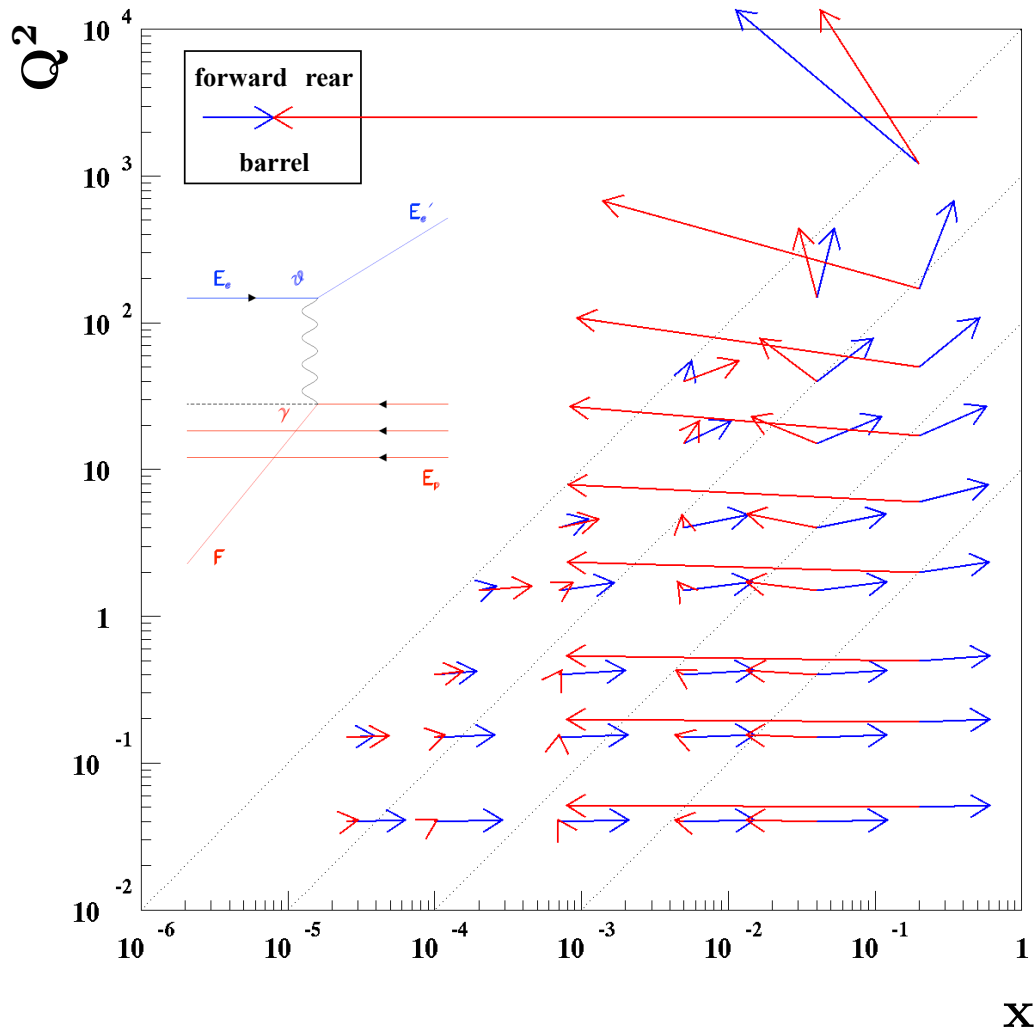

EIC Physics Pillars

- EIC kinematic considerations: $E_e=10\text{GeV}$ X $E_p=250\text{GeV}$ ($\sqrt{s}=100\text{GeV}$)

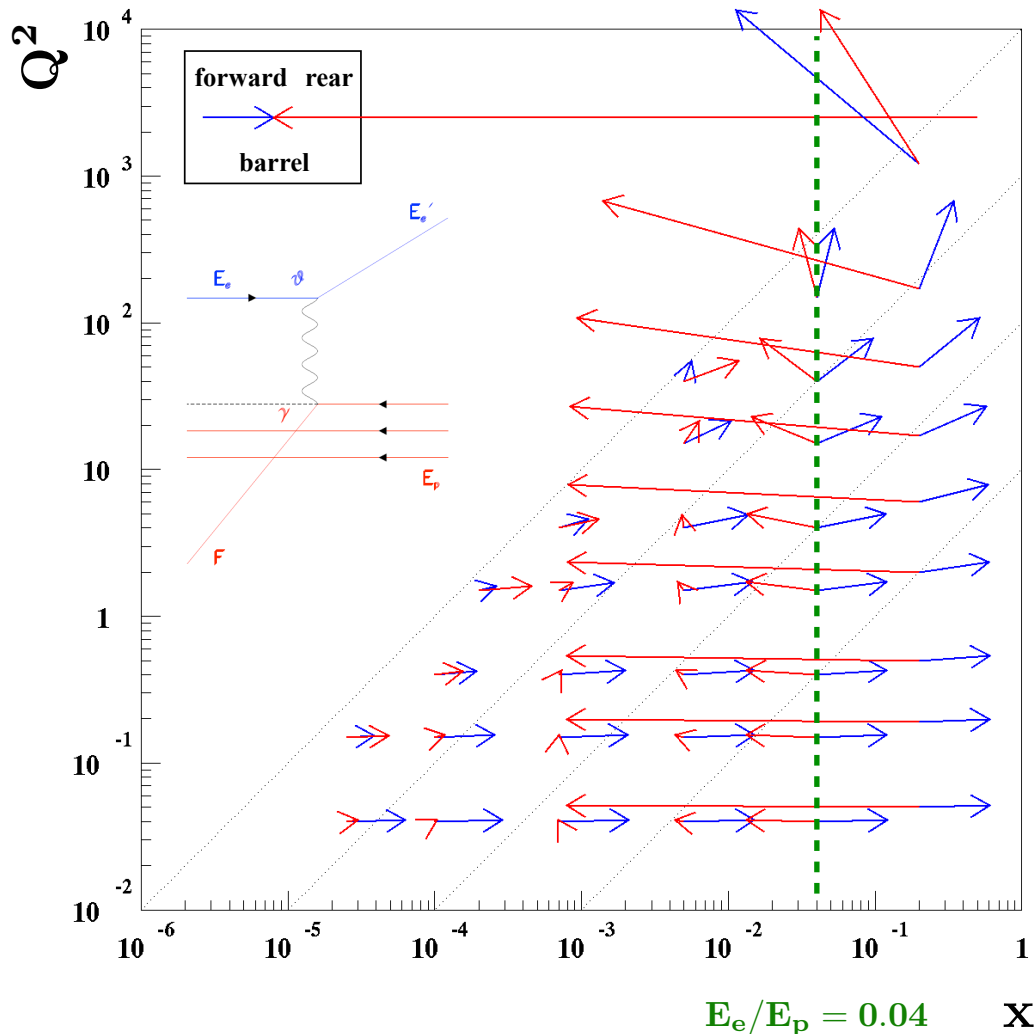

Kinematic peak location!



EIC Physics Pillars

- EIC kinematic considerations: $E_e=10\text{GeV}$ X $E_p=250\text{GeV}$ ($\sqrt{s}=100\text{GeV}$)

EIC Physics Pillars

- EIC kinematic considerations: $E_e=10\text{GeV}$ X $E_p=250\text{GeV}$ ($\sqrt{s}=100\text{GeV}$)

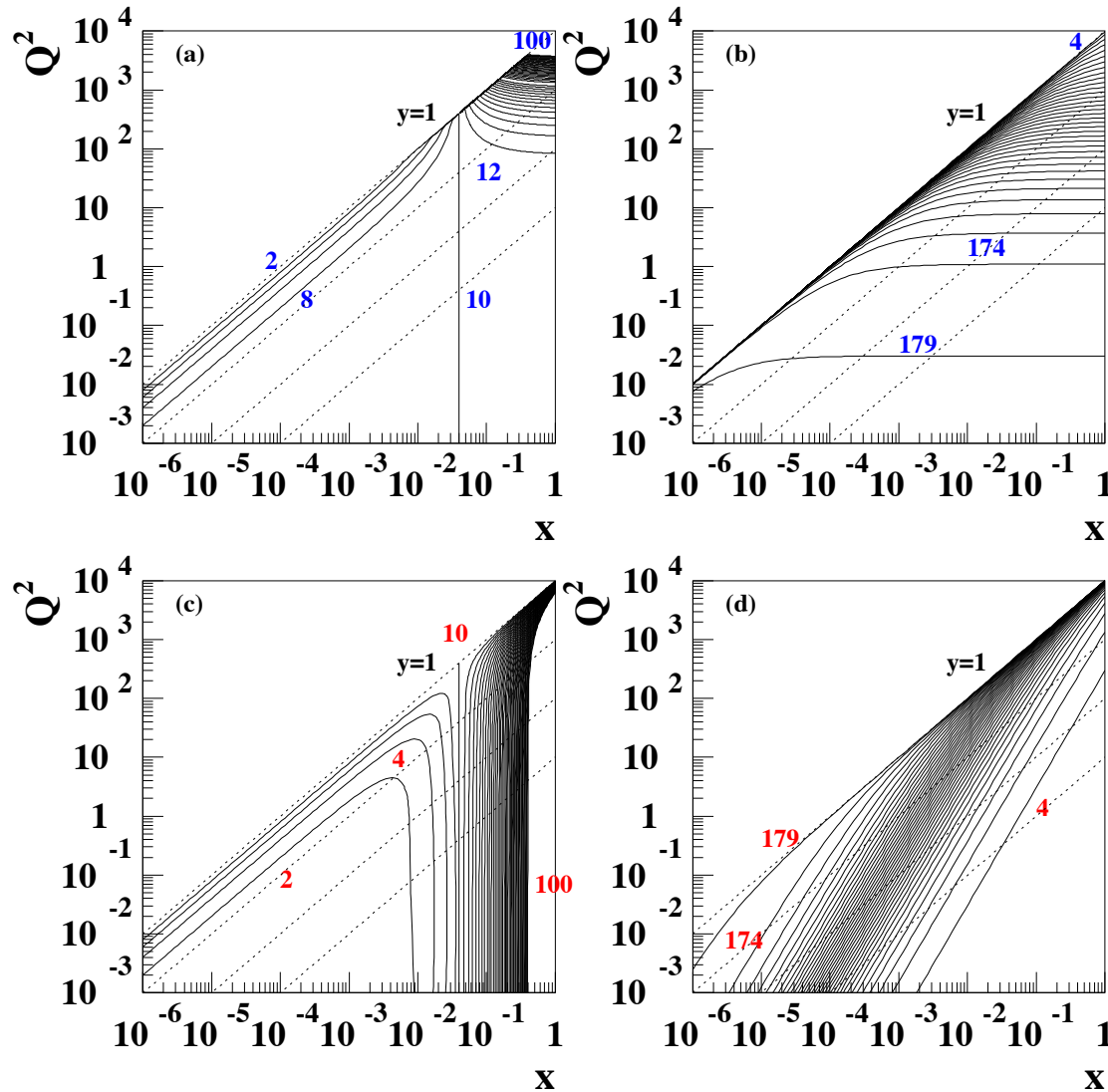

EIC Physics Pillars

- EIC kinematic considerations: $E_e=10\text{GeV}$ X $E_p=250\text{GeV}$ ($\sqrt{s}=100\text{GeV}$)

$$Q^2[x, E'_e] = \frac{x s \left(1 - \frac{E'_e}{E_e}\right)}{1 - \frac{x s}{4 E_e^2}}$$

Fixed E'_e

2GeV steps:

2GeV-100GeV

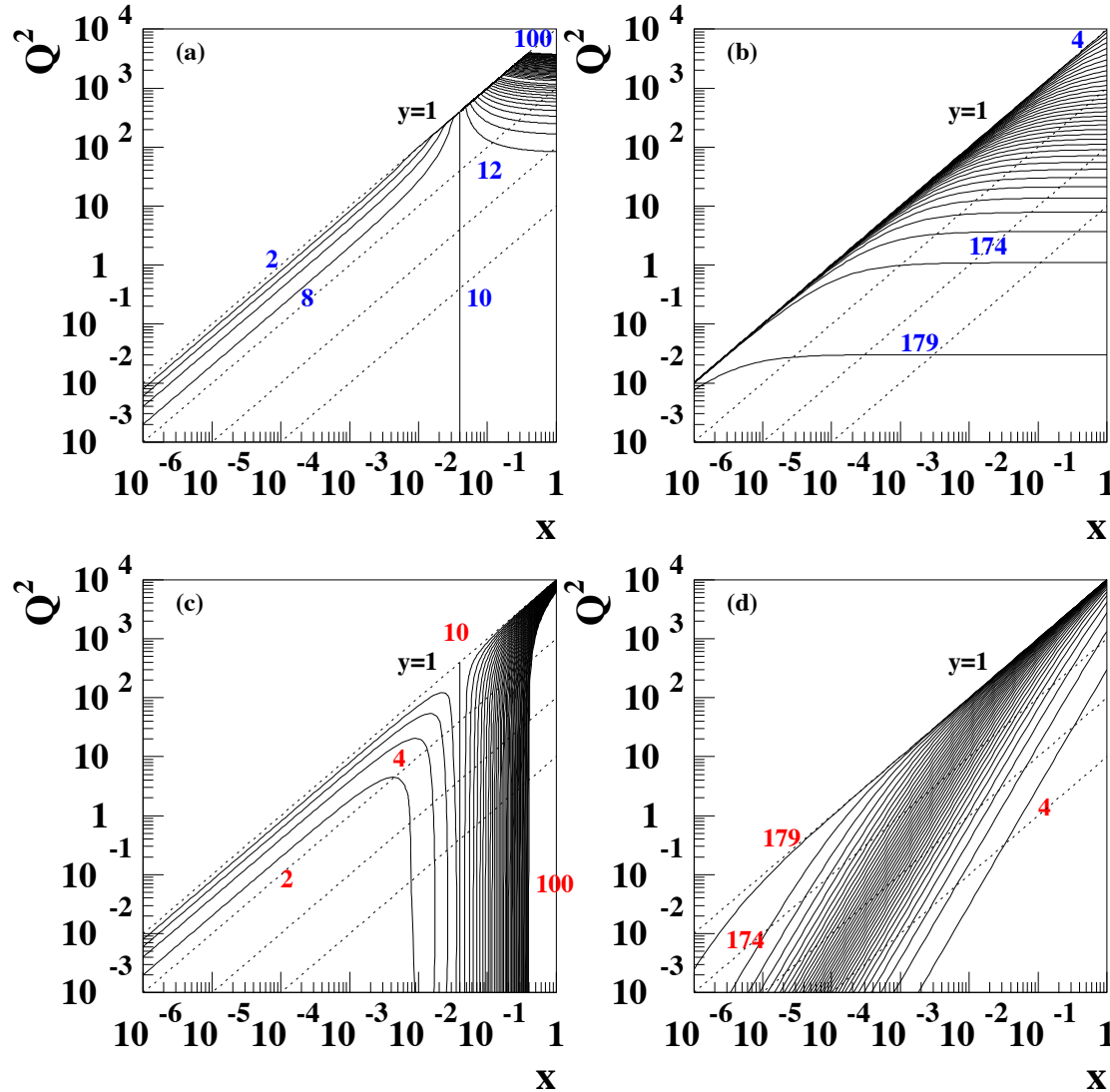

EIC Physics Pillars

- EIC kinematic considerations: $E_e=10\text{GeV}$ X $E_p=250\text{GeV}$ ($\sqrt{s}=100\text{GeV}$)

$$Q^2[x, E'_e] = \frac{x s \left(1 - \frac{E'_e}{E_e}\right)}{1 - \frac{x s}{4 E_e^2}}$$

Fixed E'_e

2GeV steps:
2GeV-100GeV

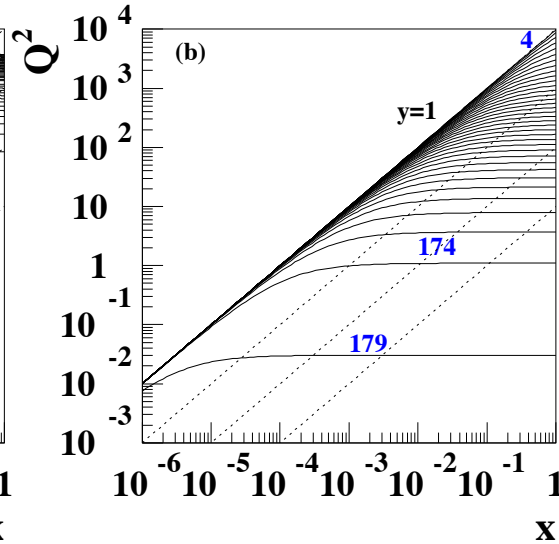
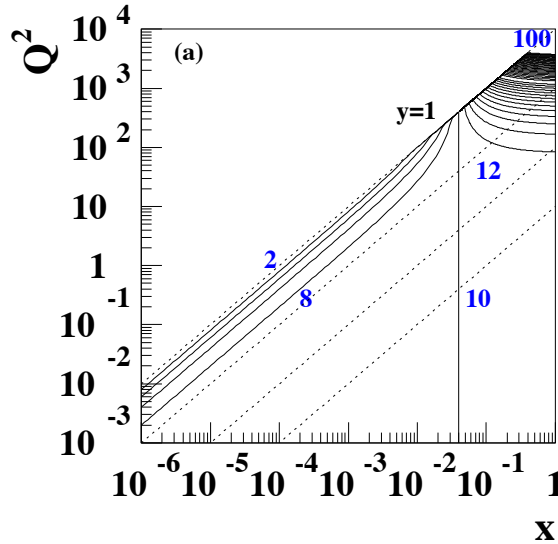

$$Q^2[x, \theta'_e] = \frac{x s}{\frac{x s}{4 E_e^2} \tan^2 \frac{\theta'_e}{2} + 1}$$

Fixed θ'_e

5° steps: 4°-179°

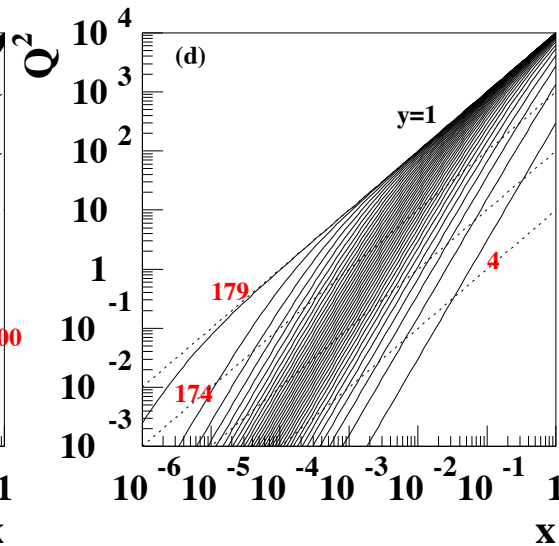
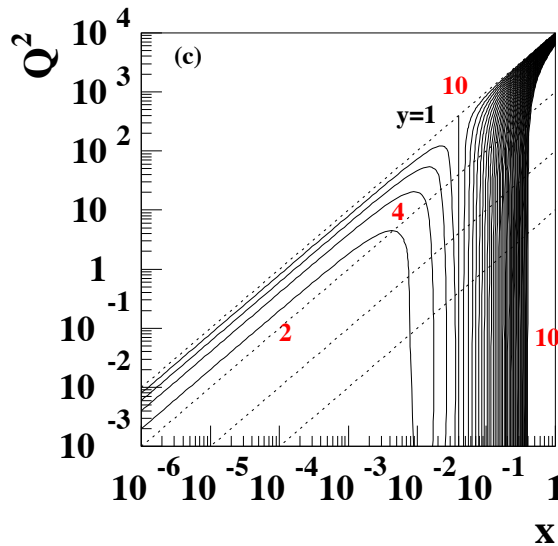

EIC Physics Pillars

- EIC kinematic considerations: $E_e=10\text{GeV}$ X $E_p=250\text{GeV}$ ($\sqrt{s}=100\text{GeV}$)

$$Q^2[x, E'_e] = \frac{xs \left(1 - \frac{E'_e}{E_e}\right)}{1 - \frac{xs}{4E_e^2}}$$

Fixed E'_e

2GeV steps:
2GeV-100GeV

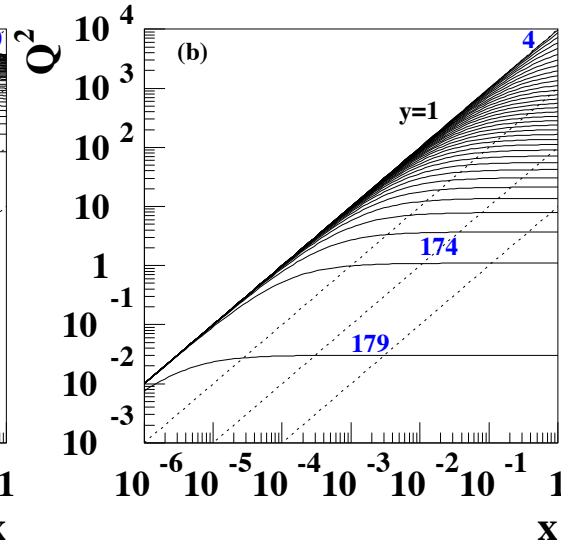
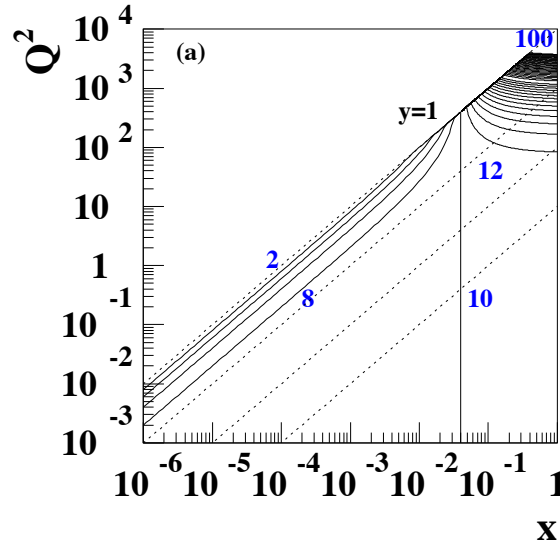

$$Q^2[x, \theta'_e] = \frac{xs}{\frac{xs}{4E_e^2} \tan^2 \frac{\theta'_e}{2} + 1}$$

Fixed θ'_e

5° steps: 4°-179°

Fixed F

2GeV steps:
2GeV-100GeV

$$Q^2[x, F] = \frac{4E_e F - sx}{\frac{4E_e^2}{sx} - 1}$$

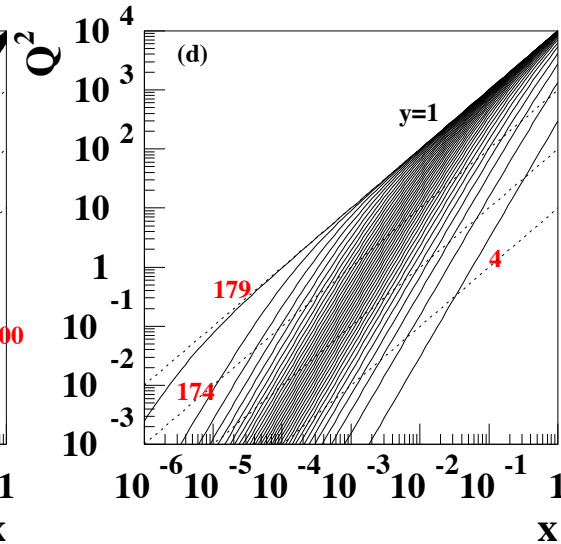
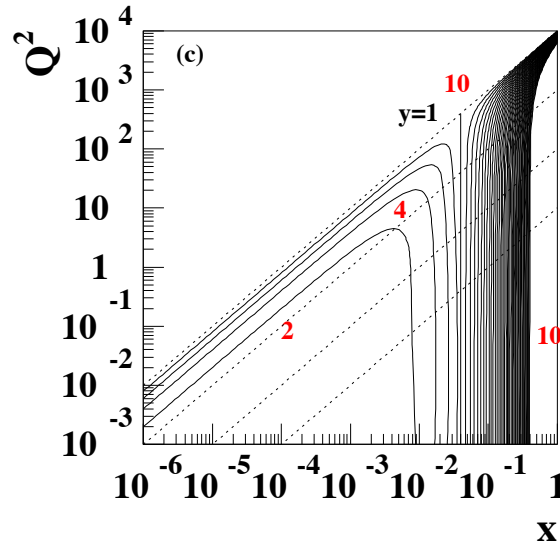

EIC Physics Pillars

- EIC kinematic considerations: $E_e=10\text{GeV}$ X $E_p=250\text{GeV}$ ($\sqrt{s}=100\text{GeV}$)

$$Q^2[x, E'_e] = \frac{xs \left(1 - \frac{E'_e}{E_e}\right)}{1 - \frac{xs}{4E_e^2}}$$

Fixed E'_e

2GeV steps:
2GeV-100GeV

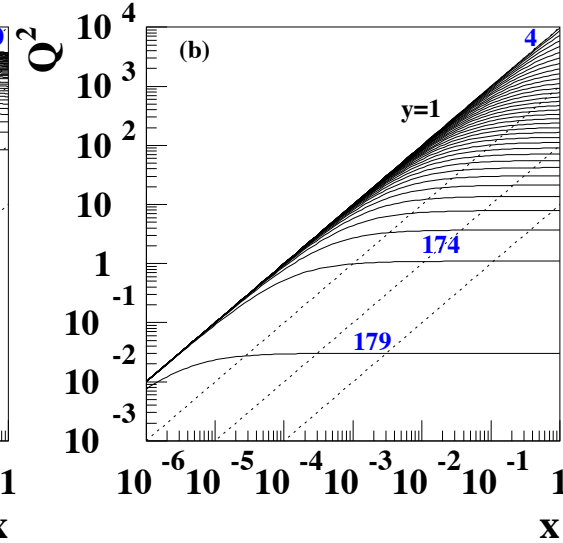
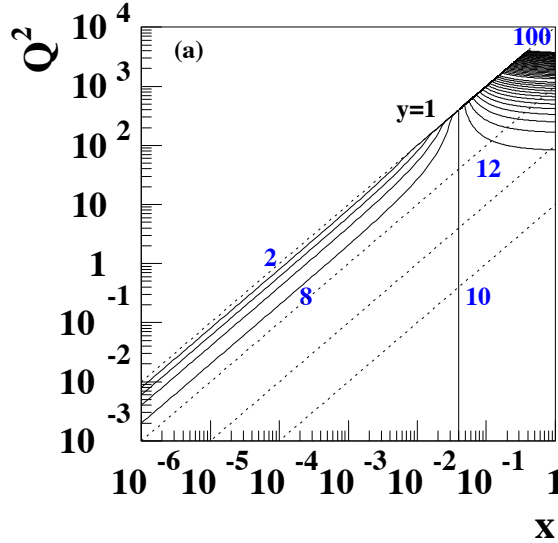

$$Q^2[x, \theta'_e] = \frac{xs}{\frac{xs}{4E_e^2} \tan^2 \frac{\theta'_e}{2} + 1}$$

Fixed θ'_e

5° steps: 4°-179°

Fixed F

2GeV steps:
2GeV-100GeV

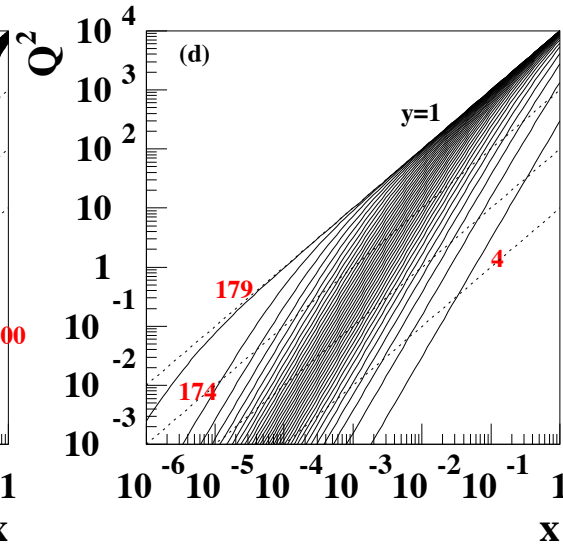
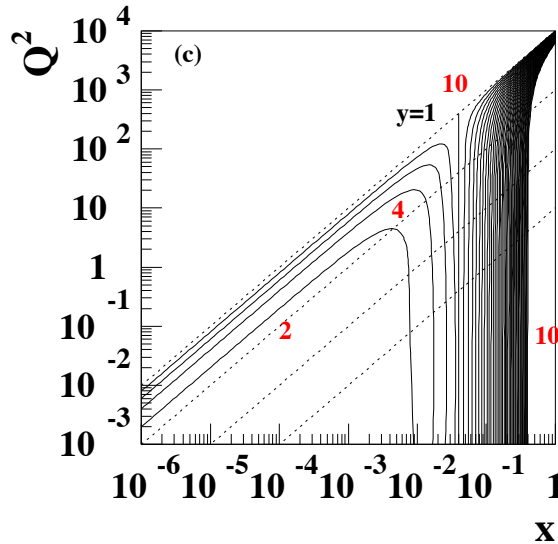

Fixed γ

5° steps:
4°-179°

$$Q^2[x, F] = \frac{4E_e F - sx}{\frac{4E_e^2}{sx} - 1}$$

$$Q^2[x, \gamma] = \frac{sx}{\frac{4E_e^2}{sx} \cot^2 \frac{\gamma}{2} + 1}$$

EIC Physics Pillars

- EIC kinematic considerations: $E_e=10\text{GeV}$ X $E_p=250\text{GeV}$ ($\sqrt{s}=100\text{GeV}$)

$$Q^2[x, E'_e] = \frac{xs \left(1 - \frac{E'_e}{E_e}\right)}{1 - \frac{xs}{4E_e^2}}$$

Fixed E'_e

2GeV steps:
2GeV-100GeV

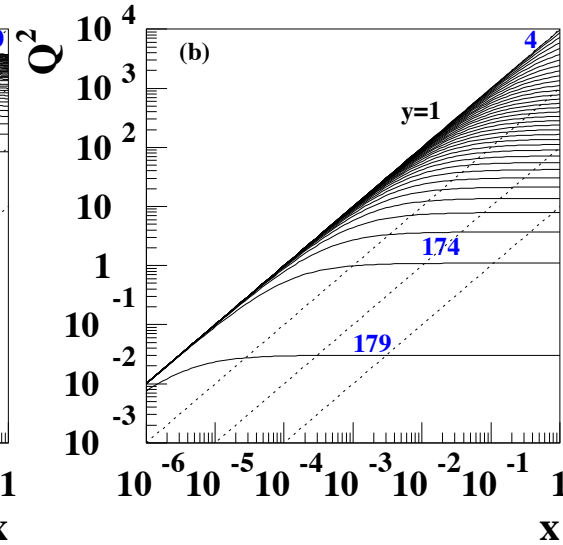
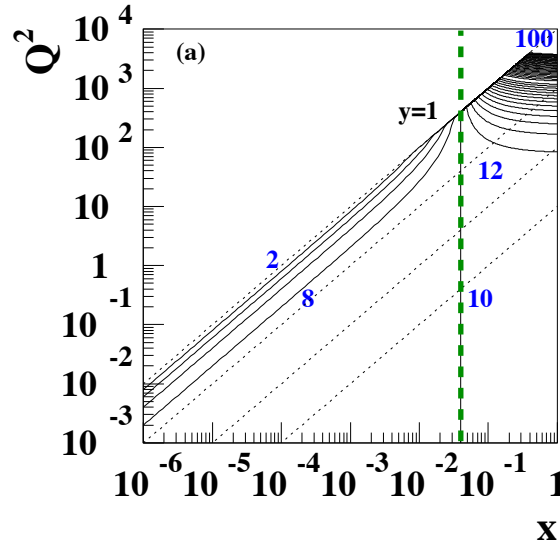

$$Q^2[x, \theta'_e] = \frac{xs}{\frac{xs}{4E_e^2} \tan^2 \frac{\theta'_e}{2} + 1}$$

Fixed θ'_e

5° steps: 4°-179°

Fixed F

2GeV steps:
2GeV-100GeV

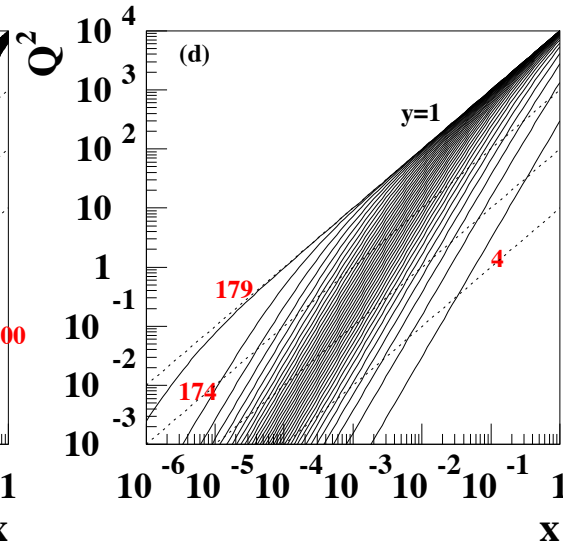
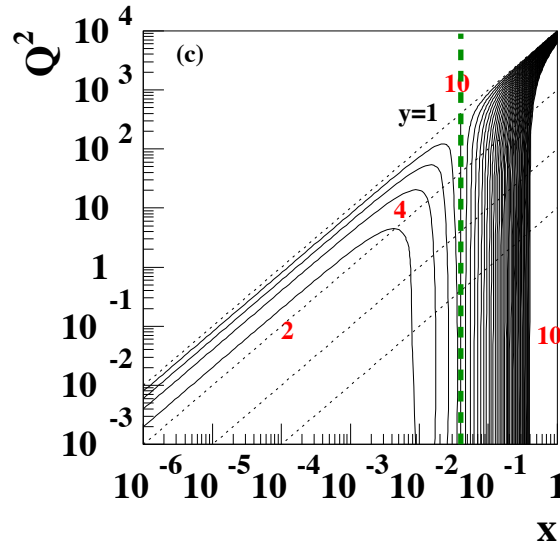

Fixed γ

5° steps:
4°-179°

$$Q^2[x, F] = \frac{4E_e F - sx}{\frac{4E_e^2}{sx} - 1}$$

$$Q^2[x, \gamma] = \frac{sx}{\frac{4E_e^2}{sx} \cot^2 \frac{\gamma}{2} + 1}$$

EIC Physics Pillars

Global properties: Spin

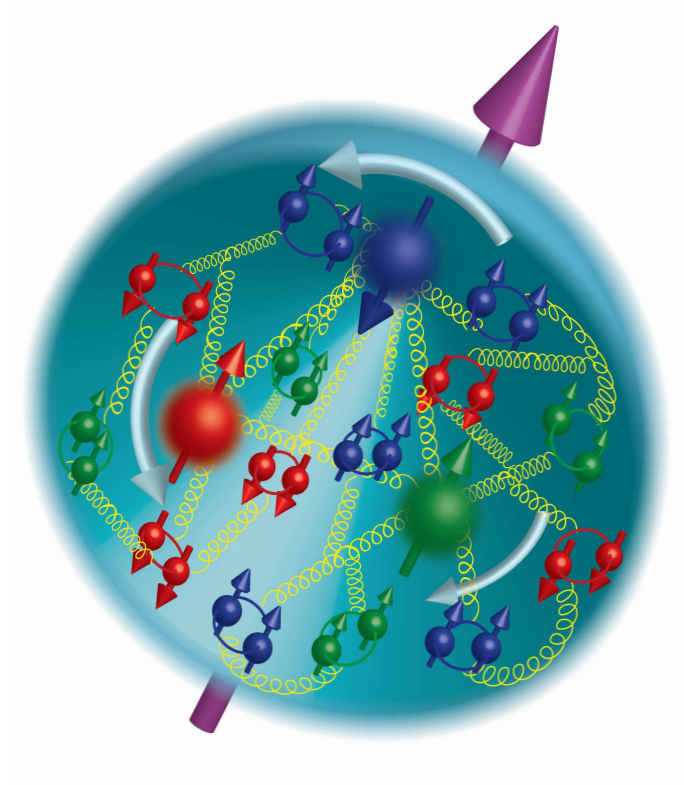



EIC Physics Pillars

Spin and Flavor Structure of the Nucleon

arXiv:1708.01527

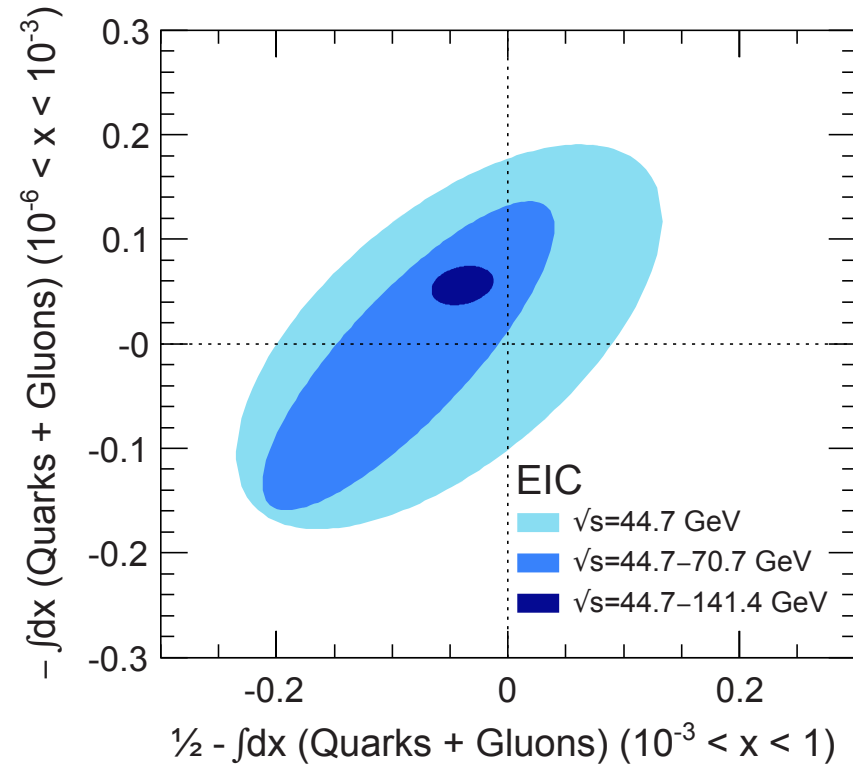
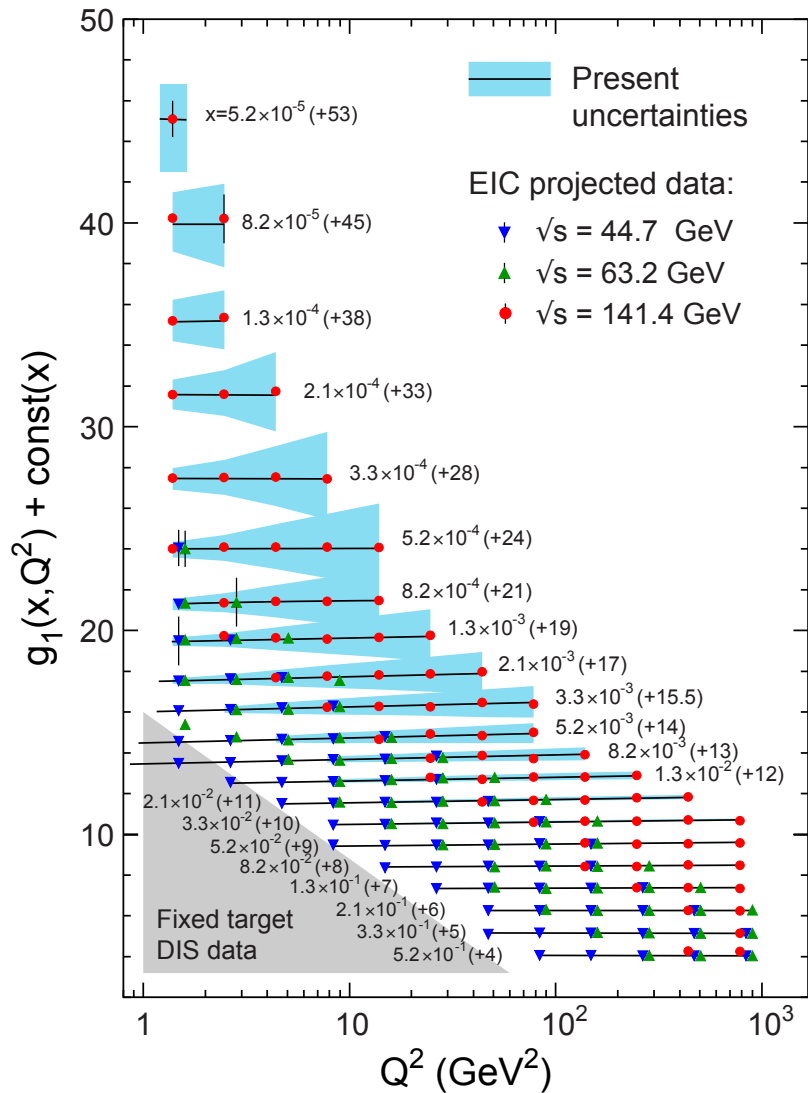

- g_1 stat. uncertainty projections for 10fb⁻¹ for range of CME in comparison to DSSV14 predictions incl. uncertainties
- EIC impact on the knowledge of the integral of the quark + gluon spin contribution vs. orbital angular momentum



EIC Physics Pillars

Impact on proton spin

E. Aschenauer, R. Sassot and M. Stratmann, Phys. Rev. D92 (2015) 094030.

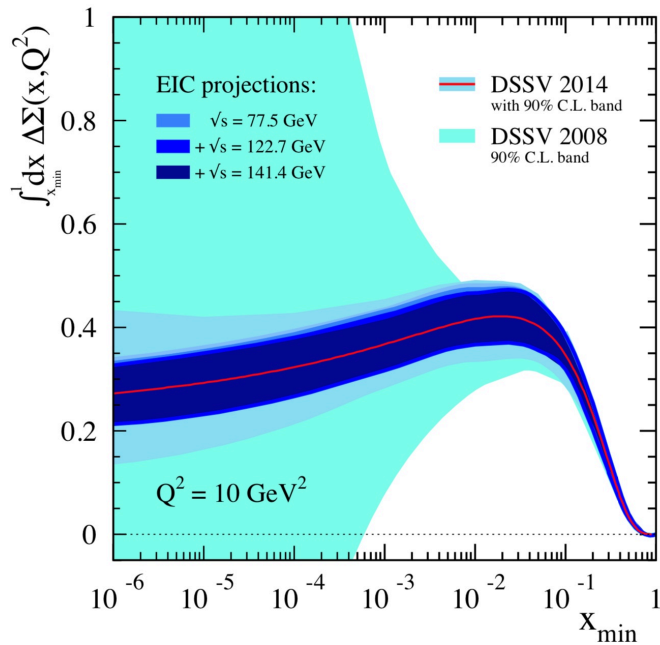

Quark Spin

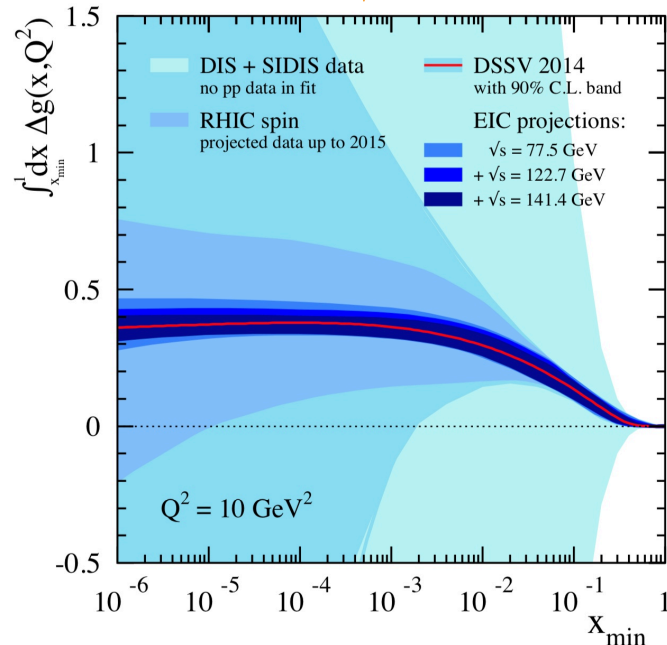

Gluon Spin

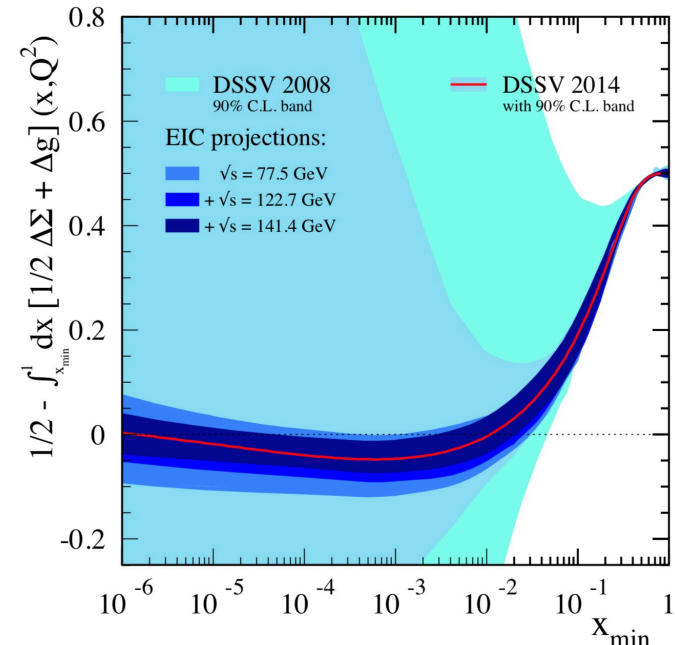

Orbital Angular Momentum

EIC Physics Pillars

Nucleon 3D structure

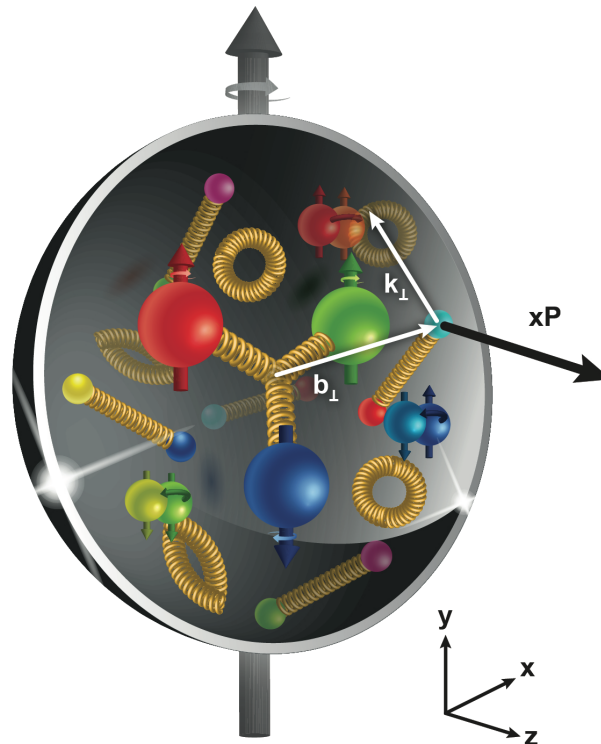

EIC Physics Pillars

□ Transverse Momentum Distribution and Spatial Imaging

$$f(x, k_T) \quad 1+2D$$

Transverse Momentum Distribution (TMD)

$$\int d^2 b_T \quad W(x, b_T, k_T) \quad \int d^2 k_T$$

Wigner
Distribution

$$f(x, b_T) \quad 1+2D$$

Impact Parameter Distribution

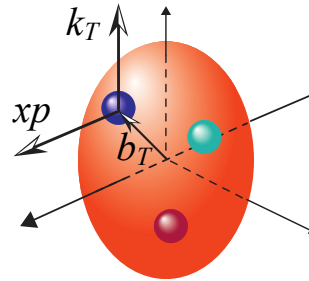

EIC Physics Pillars

□ Transverse Momentum Distribution and Spatial Imaging

arXiv:1212.1701

$$f(x, k_T) \quad 1+2D$$

$$\int d^2 b_T \quad W(x, b_T, k_T) \quad \int d^2 k_T$$

$$f(x, b_T) \quad 1+2D$$

Transverse Momentum Distribution (TMD)

Wigner
Distribution

Impact Parameter Distribution

quarks

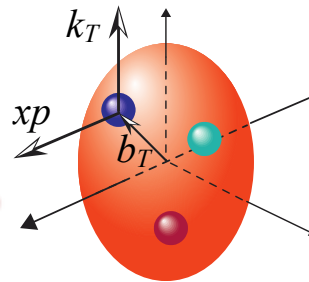
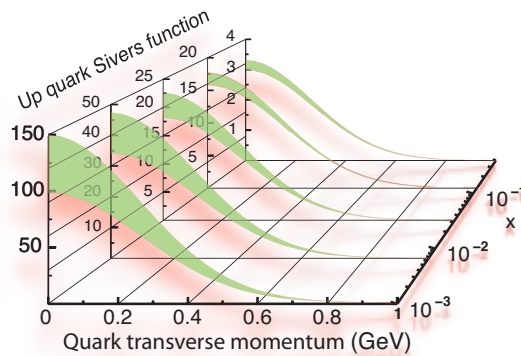
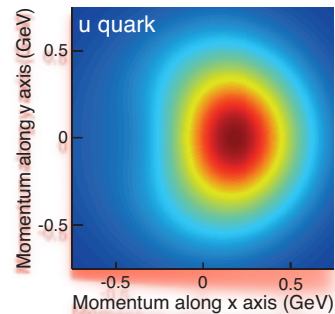

- Spin-dependent 1+2D momentum space (transverse) images from semi-inclusive scattering

EIC Physics Pillars

Transverse Momentum Distribution and Spatial Imaging

arXiv:1212.1701

$$f(x, k_T) \quad 1+2D$$

Transverse Momentum Distribution (TMD)

$$\int d^2 b_T \quad W(x, b_T, k_T) \quad \int d^2 k_T$$

Wigner Distribution

$$f(x, b_T) \quad 1+2D$$

Impact Parameter Distribution

quarks

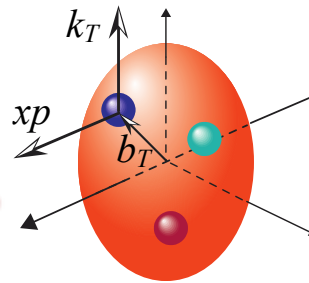
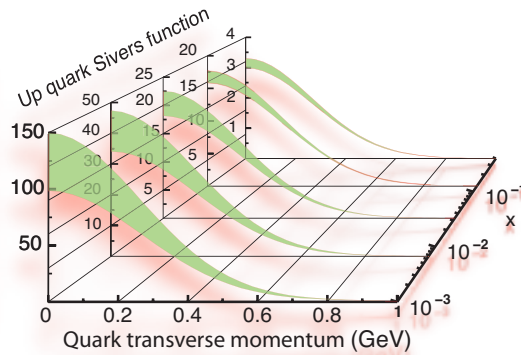
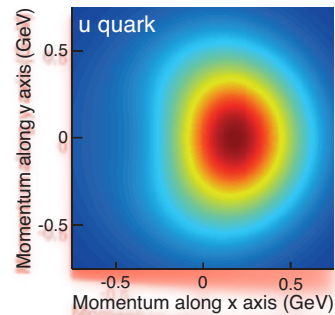

gluons

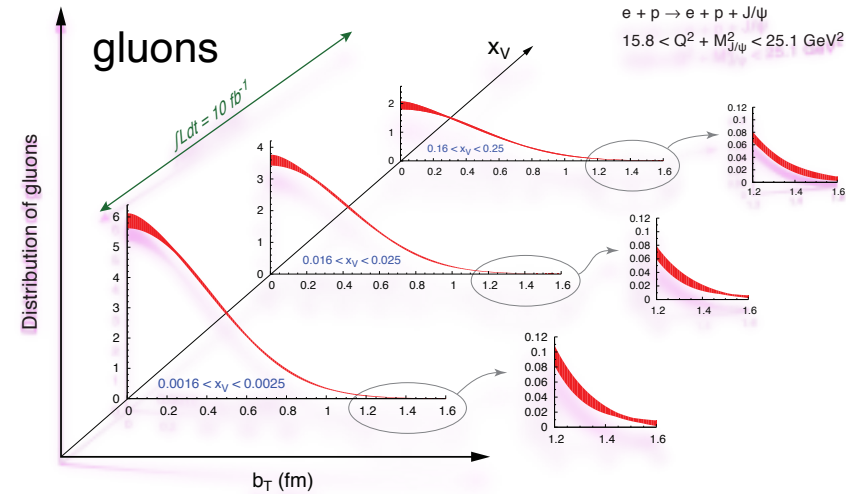

- Spin-dependent 1+2D momentum space (transverse) images from semi-inclusive scattering

- Spin-dependent 1+2D impact parameter (transverse) images from exclusive scattering

$$\begin{aligned} & \text{Fourier transf.} \\ & b_T \leftrightarrow \Delta: t = -\Delta^2 \\ & H(x, 0, t) \\ & \uparrow \xi = 0 \\ & H(x, \xi, t) \end{aligned}$$

Generalized Parton Distribution (GPD)

EIC Physics Pillars

Low-x physics

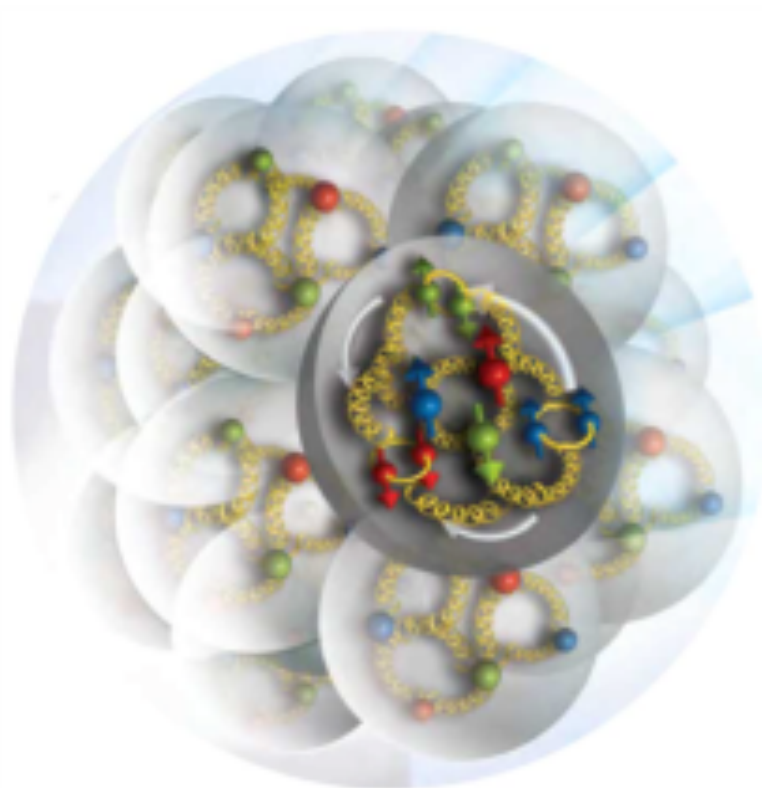

EIC Physics Pillars

QCD dynamics

arXiv:1708.01527

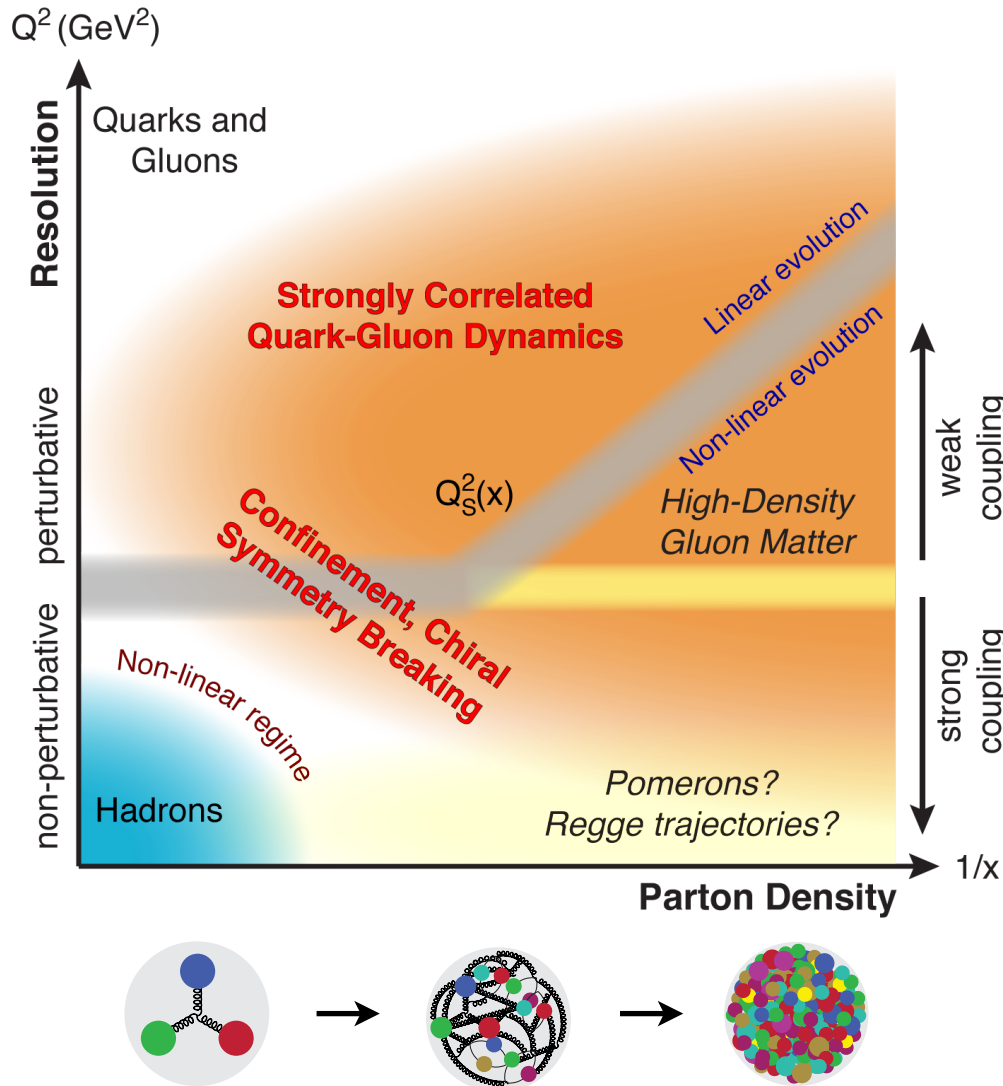

- Explore QCD landscape in various aspects over a wide range in x and Q^2
- Heavy nuclei at high energy critical to explore high-density gluon matter!

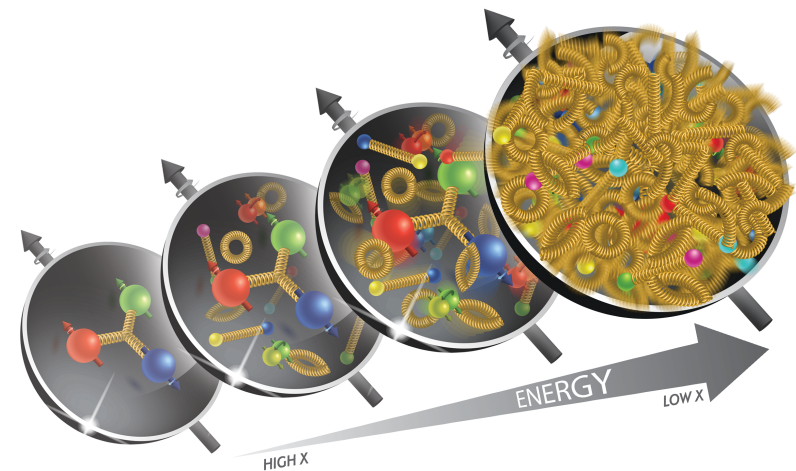

EIC Physics Pillars

Inclusive eA scattering measurements

arXiv:1708.01527

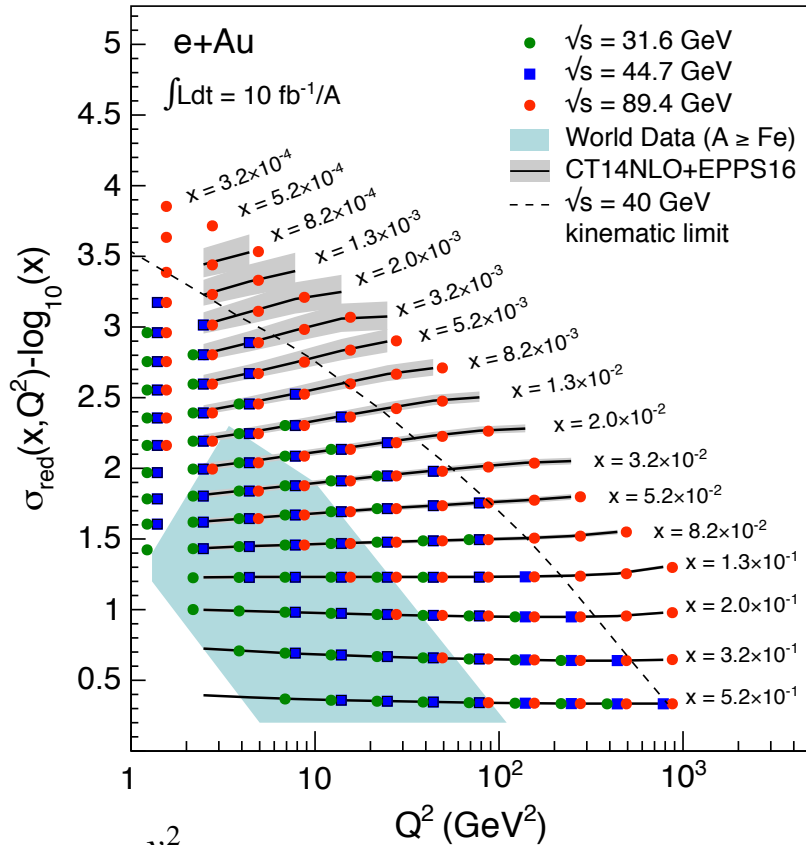

$$\sigma_{\text{red}} = F_2 - \frac{y^2}{Y_+} F_L$$

$$\left(\frac{d^2\sigma}{dx dQ^2} \right) = \frac{2\pi\alpha^2 Y_+}{x Q^4} \left(F_2 - \frac{y^2}{Y_+} F_L \right)$$

$$Y_+ = 1 + (1 - y)^2$$

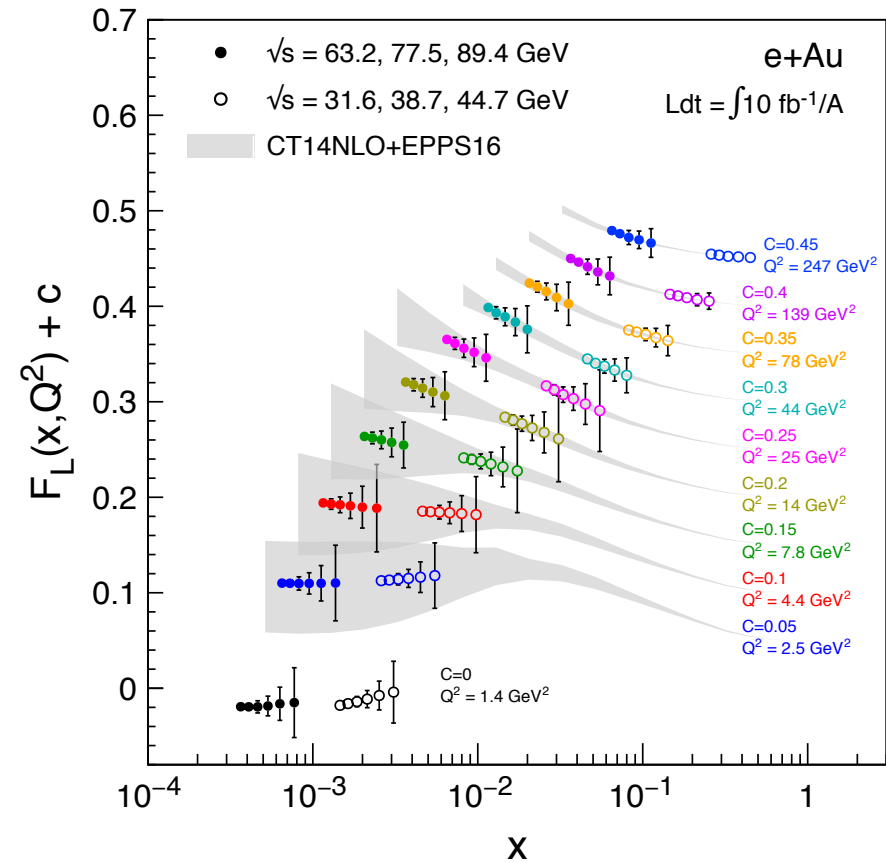

EIC Physics Pillars

Charm-associated eA scattering measurements

arXiv:1708.01527

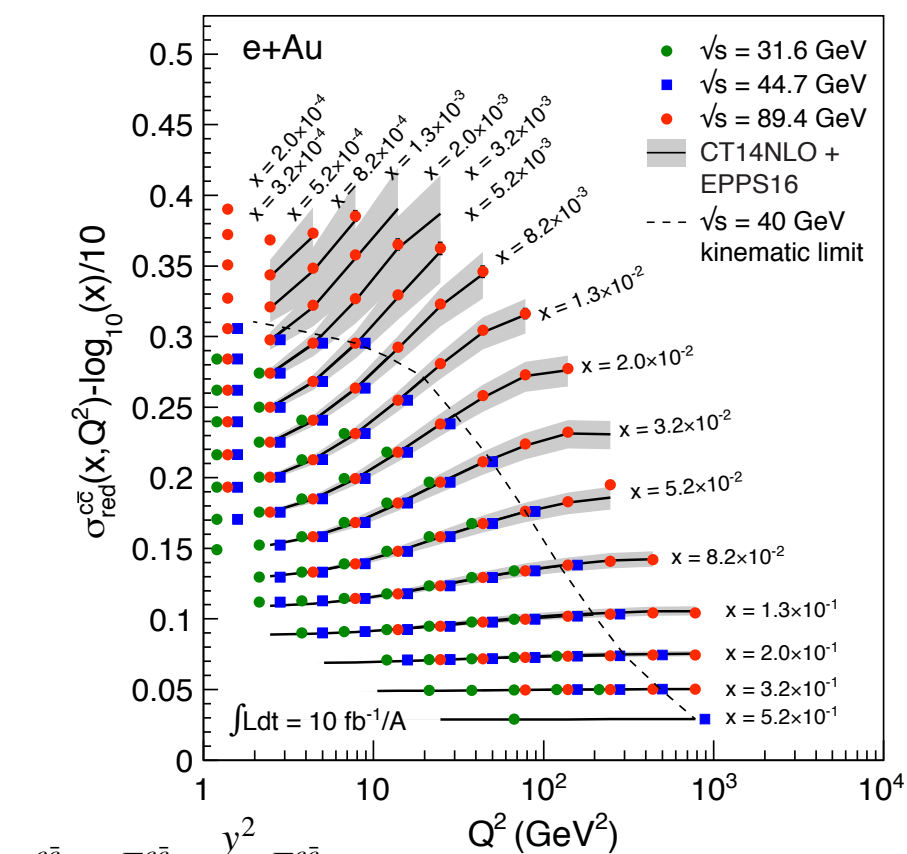

$$\sigma_{\text{red}}^{c\bar{c}} = F_2^{c\bar{c}} - \frac{y^2}{Y_+} F_L^{c\bar{c}}$$

$$\left(\frac{d^2\sigma}{dx dQ^2} \right)^{c\bar{c}} = \frac{2\pi\alpha^2 Y_+}{x Q^4} \left(F_2^{c\bar{c}} - \frac{y^2}{Y_+} F_L^{c\bar{c}} \right)$$

$$Y_+ = 1 + (1 - y)^2$$

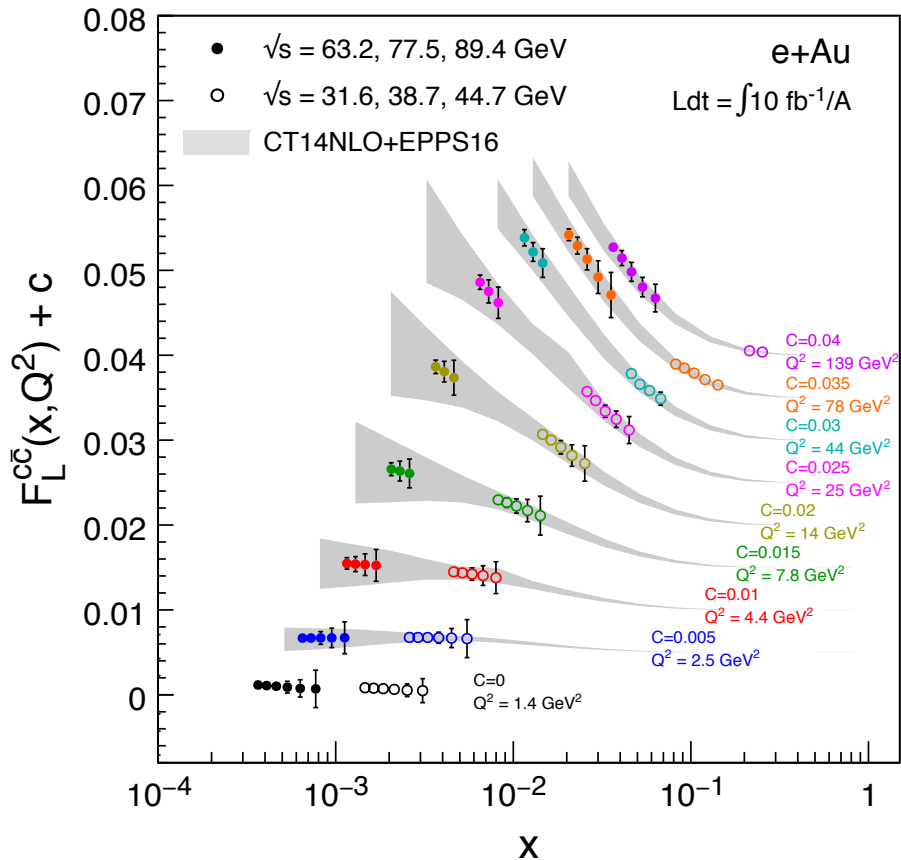

EIC Physics Pillars

Impact on nuclear gluon behavior in eA scattering

arXiv:1708.01527

Modifications of
nuclear
environment:

 R_g^{Pb}

Ratio of gluon
distribution in Pb
compared to proton

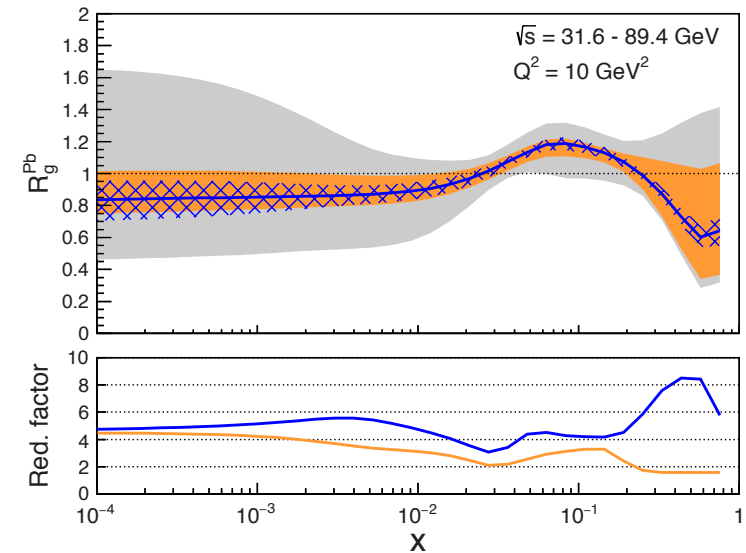
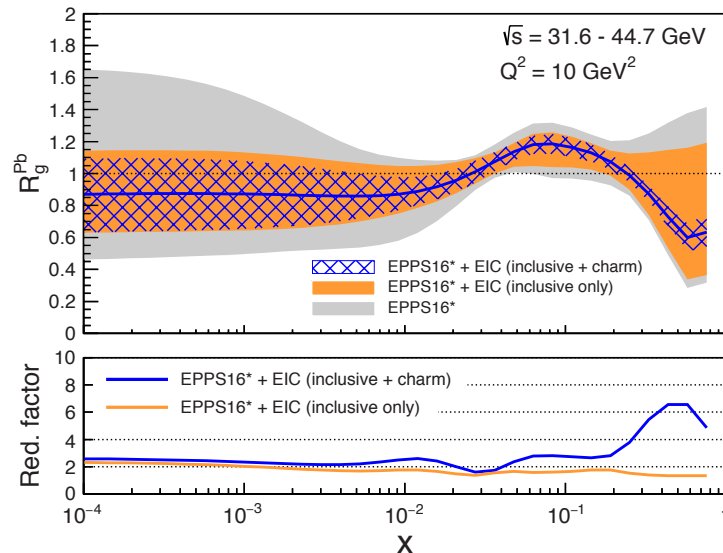
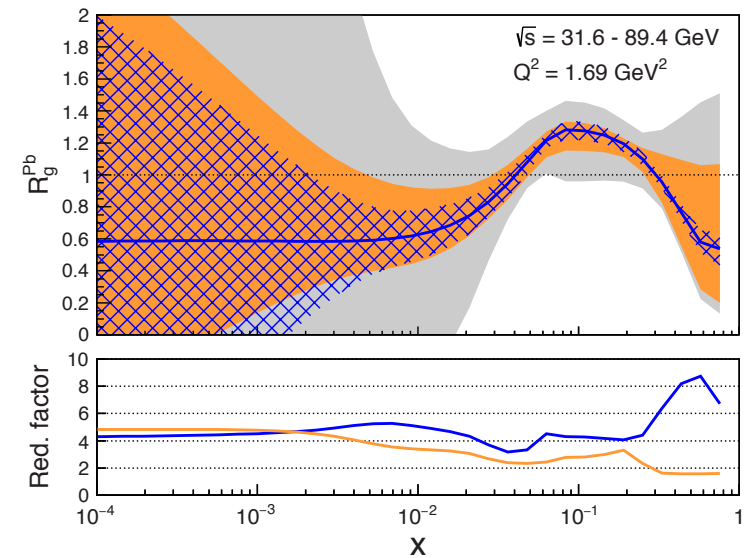
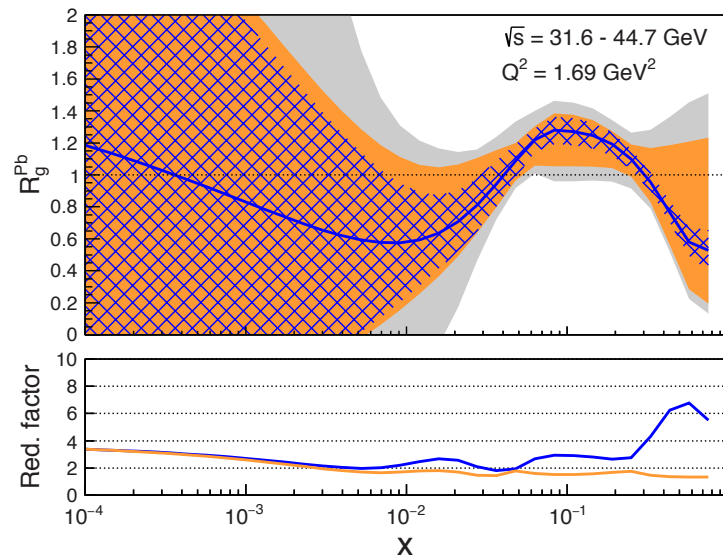

EIC Physics Pillars

Global properties: Mass

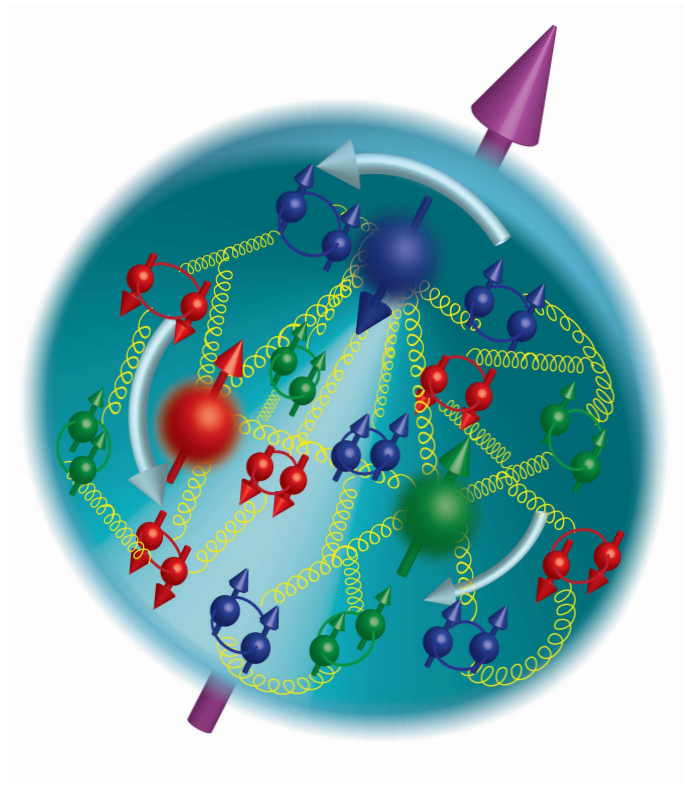

EIC Physics Pillars

□ Mass

A. Metz, Priv. com.

- Proton mass M - Relation to Energy-Momentum Tensor (EMT) $T^{\mu\nu}$

$$M = n \langle T^\mu_\mu \rangle = n \langle T^{00} \rangle \Big|_{P=0} \quad \text{with } n = \frac{1}{2M}$$

- Forward matrix element of $T_{iR}^{\mu\nu}$ ($i=q,g$): $\langle T_{iR}^{\mu\nu} \rangle = 2P^\mu P^\nu A_i(0) + 2M^2 g^{\mu\nu} \bar{C}_i(0)$

with gravitational form factors $A_i(0)$, $\bar{C}_i(0)$ at $t=0$. Conservation of EMT implies:

$$A_q(0) + A_g(0) = 0 \quad \bar{C}_q(0) + \bar{C}_g(0) = 0$$

- In the forward limit, $\langle T_{iR}^{\mu\nu} \rangle$ fully determined by two numbers!

EIC Physics Pillars

□ Nucleon mass

A. Metz, Priv. com.

- Different sum rules based on a decomposition of T_{μ}^{μ} or T^{00} :

- **2-term sum rule by Hatta, Rajan, and Tanaka**: Decomposition of T_{μ}^{μ}

$$M = n \left(\langle (T_{q,R})_{\mu}^{\mu} \rangle + \langle (T_{g,R})_{\mu}^{\mu} \rangle \right) \quad \begin{array}{l} \text{Hatta, Rajan, Tanaka, JHEP 12 (2018) 008 /} \\ \text{Tanaka, JHEP 01 (2019) 120} \end{array}$$

Formulation in terms of two independent parameters reflecting

a) **Parton momentum fraction** and

- **2-term sum rule by Lorcé**: Decomposition of T^{00}

$$M = n \left(\langle (T_{q,R})^{00} \rangle + \langle (T_{g,R})^{00} \rangle \right) \quad \text{Lorcé, EPJC 78, 120 (2018)}$$

b) **Quark mass terms / relation to trace anomaly.**

- **3-term sum rule by Rodini, Metz, Pasquini**: Decomposition of T^{00}

$$M = n \left(\langle (\mathcal{H}_q) \rangle + \langle (\mathcal{H}_m) \rangle + \langle (\mathcal{H}_g) \rangle \right) \quad \begin{array}{l} \text{Rodini, Metz, Pasquini, JHEP 09 (2020) 067 /} \\ \text{Metz, Rodini, Pasquini, PRD 102 (2020) 114042} \end{array}$$

EIC: Constrain anomaly contribution (Gluon contr. to trace anomaly) through **heavy quarkonium production!**

- **4-term sum rule by Ji**: Decomposition of T^{00}

$$M = n \left(\langle (\mathcal{H}_{q[Ji]}) \rangle + \langle (\mathcal{H}_m) \rangle + \langle (\mathcal{H}_{g[Ji]}) \rangle + \langle (\mathcal{H}_a) \rangle \right) \quad \begin{array}{l} \text{Ji, PRL 74, 1071 (1995) /} \\ \text{PRD 52, 271 (1995)} \end{array}$$

EIC Physics Pillars

Comparison of different mass sum rules: D2 renormalization scheme

A. Metz, Priv. com.

2 terms T^μ_μ

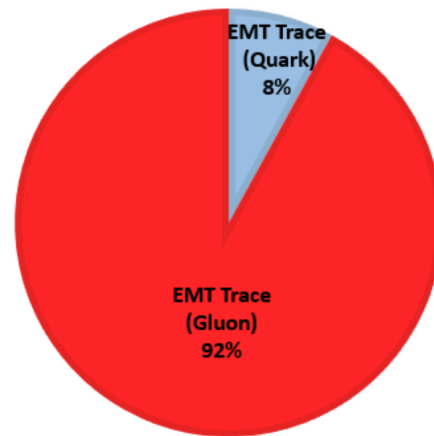

2-term sum rule by Hatta, Rajan, and Tanaka

2 terms T^{00}

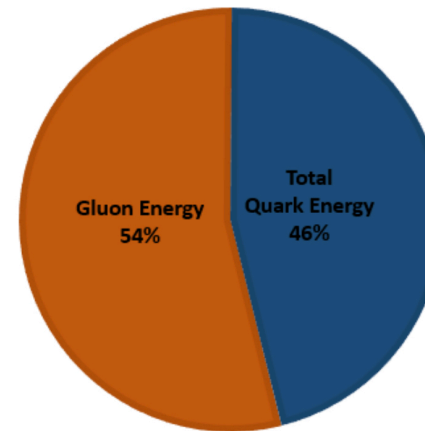

2-term sum rule by Lorcé

3 terms T^{00}

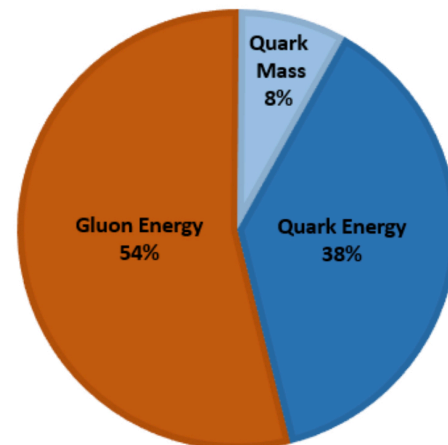

3-term sum rule by Rodini, Metz, Pasquini

4 terms T^{00}

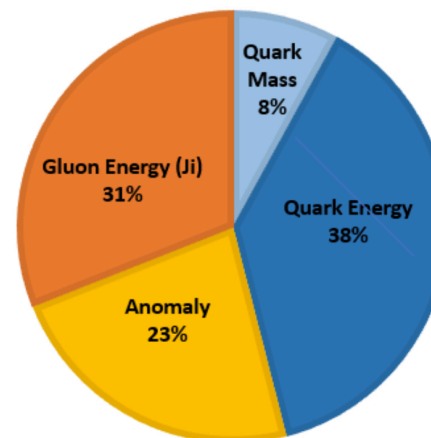

4-term sum rule by Ji

EIC Physics Pillars

EIC constraint of anomaly to nucleon mass

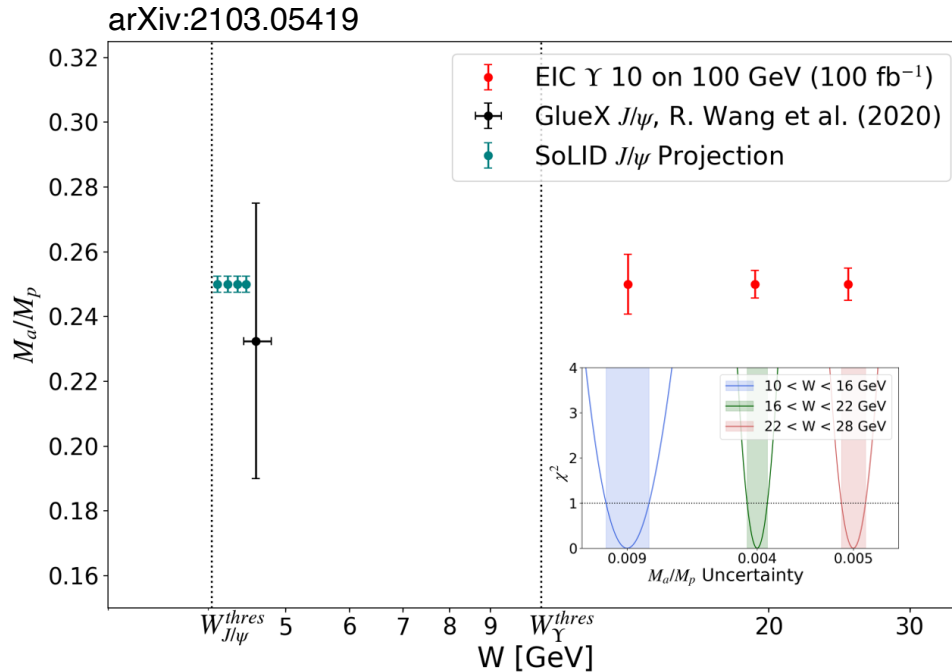

First results from GlueX and anticipated SoLID experiment!

INT workshop: "Origin of the Visible Universe: Unraveling the Proton Mass" June 13-17, 2022

<https://www.int.washington.edu/programs-and-workshops/20r-77>

Workshop Overview

INT WORKSHOP INT-20R-77

Origin of the Visible Universe: Unraveling the Proton Mass

June 13, 2022 - June 17, 2022

ORGANIZERS

Ian Cloët
Argonne National Laboratory
icloet@anl.gov

Zein-Eddine Meziani
Argonne National Laboratory
zmeziani@anl.gov

Barbara Pasquini
University of Pavia & INFN
barbara.pasquini@unipv.it

DIVERSITY COORDINATOR

Zein-Eddine Meziani
Argonne National Laboratory
zmeziani@anl.gov

PROGRAM COORDINATOR

Megan Baunsgard
206-685-4286
mib47@uw.edu

The application deadline for this event has passed.

Experimental Realization

□ EIC accelerator design

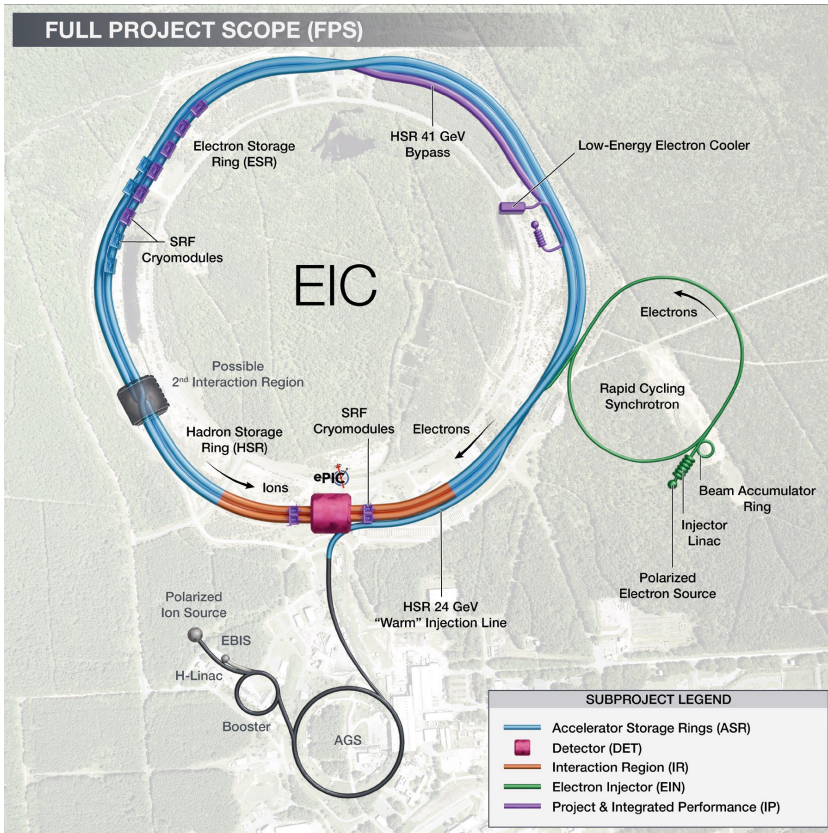

Center of Mass Energies:	20GeV - 140GeV
Luminosity:	$10^{33} - 10^{34} \text{ cm}^{-2}\text{s}^{-1}$ / 10-100fb ⁻¹ / year
Highly Polarized Beams:	70%
Large Ion Species Range:	p to U
Number of Interaction Regions:	Up to 2!

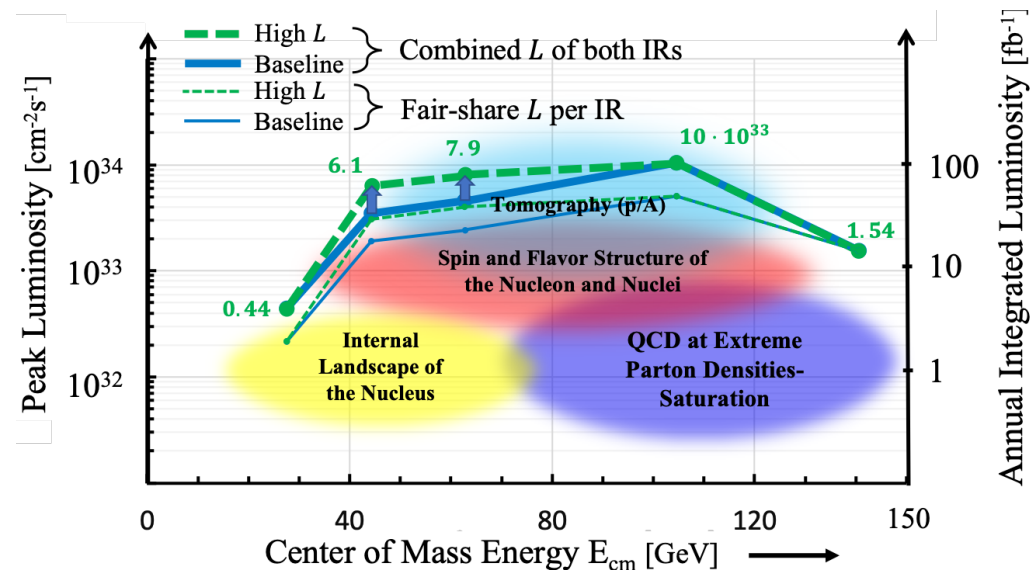



ePIC Detector Layout

- Overview of processes and final states

ePIC Detector Layout

□ Overview of processes and final states

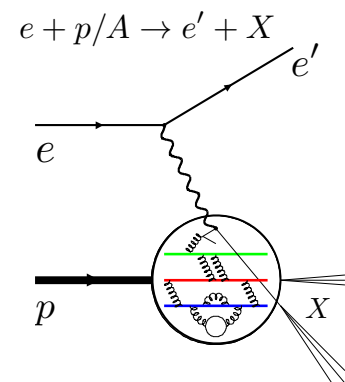

Inclusive DIS

ePIC Detector Layout

□ Overview of processes and final states

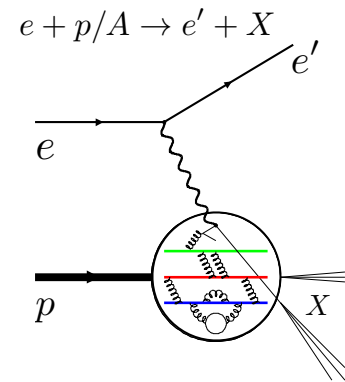

Inclusive DIS

- **Inclusive:** Unpolarized $f_i(x, Q^2)$ and helicity distribution $\Delta f_i(x, Q^2)$ functions through unpolarized and polarized structure function measurements (F_2 , F_L , g_1)

ePIC Detector Layout

□ Overview of processes and final states

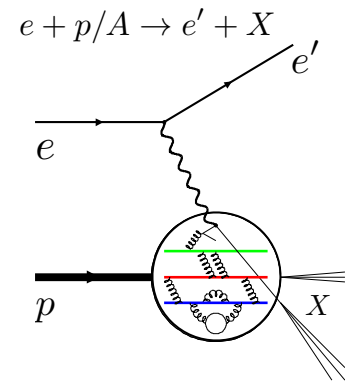

Inclusive DIS

- **Inclusive:** Unpolarized $f_i(x, Q^2)$ and helicity distribution $\Delta f_i(x, Q^2)$ functions through unpolarized and polarized structure function measurements (F_2 , F_L , g_1)
- Define kinematics (x , y , Q^2) through electron (e-ID and energy+angular measurement critical) / hadron final state or combination of both depending on kinematic x - Q^2 region

ePIC Detector Layout

Overview of processes and final states

$$e + p/A \rightarrow e' + X$$

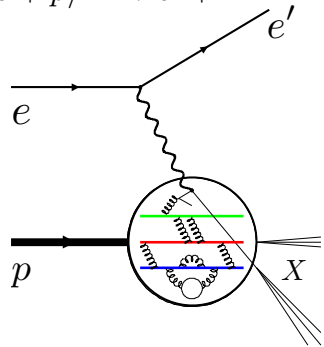

Inclusive DIS

- **Inclusive:** Unpolarized $f_i(x, Q^2)$ and helicity distribution $\Delta f_i(x, Q^2)$ functions through unpolarized and polarized structure function measurements (F_2 , F_L , g_1)
- Define kinematics (x , y , Q^2) through electron (e-ID and energy+angular measurement critical) / hadron final state or combination of both depending on kinematic x - Q^2 region

$$e + p/A \rightarrow e' + h + X$$

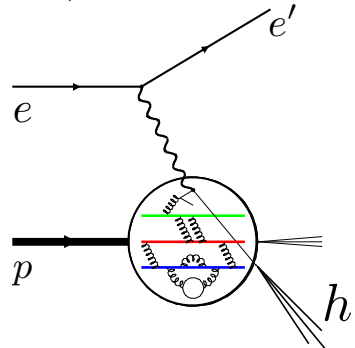

Semi-Inclusive DIS (SDIS)

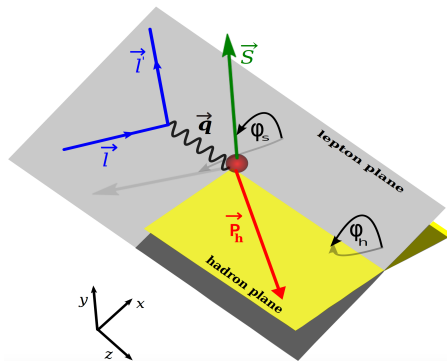

ePIC Detector Layout

Overview of processes and final states

$$e + p/A \rightarrow e' + X$$

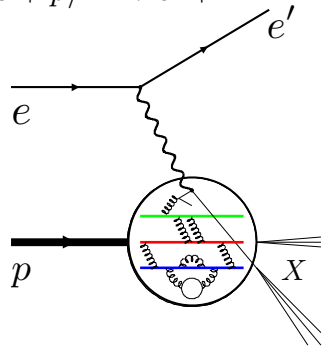

Inclusive DIS

- **Inclusive:** Unpolarized $f_i(x, Q^2)$ and helicity distribution $\Delta f_i(x, Q^2)$ functions through unpolarized and polarized structure function measurements (F_2 , F_L , g_1)

Semi-Inclusive DIS (SDIS)

$$e + p/A \rightarrow e' + h + X$$

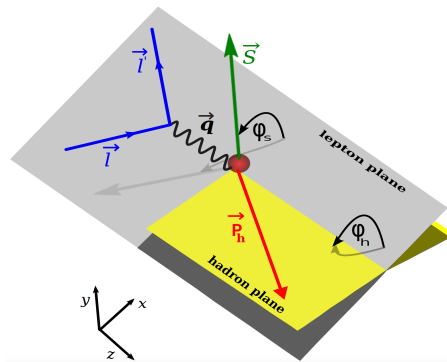
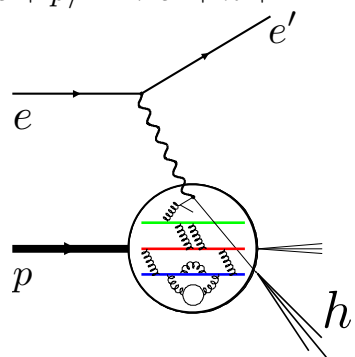

- Define kinematics (x , y , Q^2) through electron (e-ID and energy+angular measurement critical) / hadron final state or combination of both depending on kinematic x - Q^2 region
- **SDIS:** Flavor tagging through hadron identification studying FF / TMD's (Transverse momentum, k_T , dependence) requiring azimuthal asymmetry measurement - Full azimuthal acceptance

ePIC Detector Layout

□ Overview of processes and final states

$$e + p/A \rightarrow e' + X$$

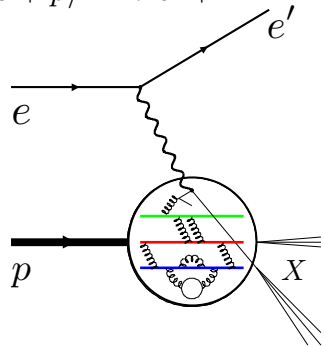

Inclusive DIS

- **Inclusive:** Unpolarized $f_i(x, Q^2)$ and helicity distribution $\Delta f_i(x, Q^2)$ functions through unpolarized and polarized structure function measurements (F_2 , F_L , g_1)

Semi-Inclusive DIS (SDIS)

$$e + p/A \rightarrow e' + h + X$$

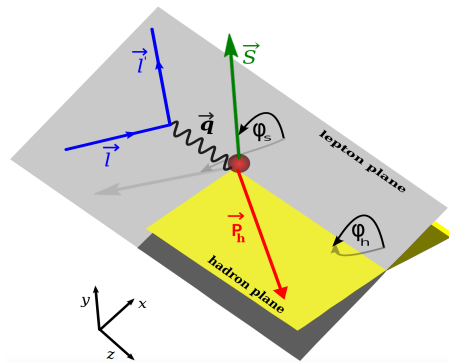
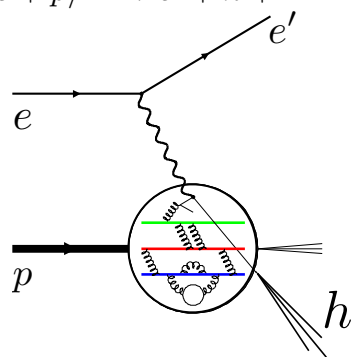

- Define kinematics (x , y , Q^2) through electron (e-ID and energy+angular measurement critical) / hadron final state or combination of both depending on kinematic x - Q^2 region

- **SDIS:** Flavor tagging through hadron identification studying FF / TMD's (Transverse momentum, k_T , dependence) requiring azimuthal asymmetry measurement - Full azimuthal acceptance
- **Heavy flavor** (charm / bottom): Excellent secondary vertex reconstruction

ePIC Detector Layout

Overview of processes and final states

$$e + p/A \rightarrow e' + X$$

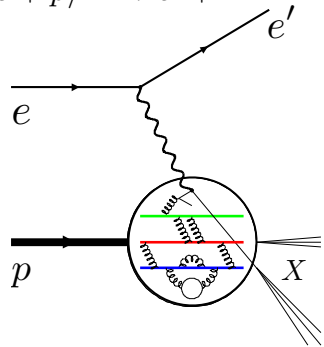

Inclusive DIS

- Inclusive:** Unpolarized $f_i(x, Q^2)$ and helicity distribution $\Delta f_i(x, Q^2)$ functions through unpolarized and polarized structure function measurements (F_2, F_L, g_1)

$$e + p/A \rightarrow e' + h + X$$

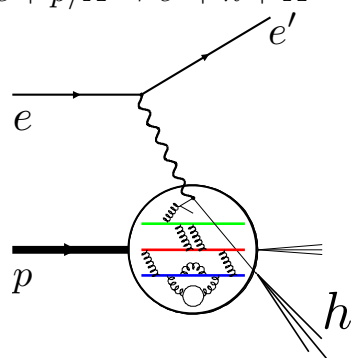

Semi-Inclusive DIS (SDIS)

- Define kinematics (x, y, Q^2) through electron (e-ID and energy+angular measurement critical) / hadron final state or combination of both depending on kinematic $x-Q^2$ region

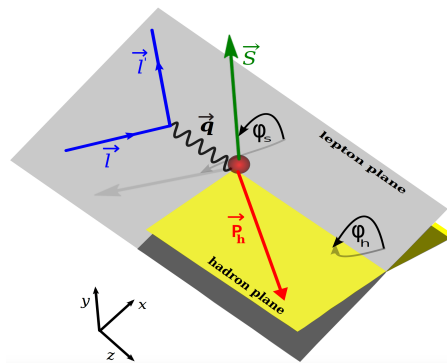

- SDIS:** Flavor tagging through hadron identification studying FF / TMD's (Transverse momentum, k_T , dependence) requiring azimuthal asymmetry measurement - Full azimuthal acceptance
- Heavy flavor** (charm / bottom): Excellent secondary vertex reconstruction

$$e + p/A \rightarrow e' + N'/A' + \gamma/m$$

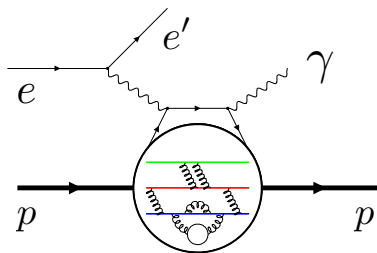

Deeply-Virtual Compton Scattering (DVCS)

ePIC Detector Layout

Overview of processes and final states

$$e + p/A \rightarrow e' + X$$

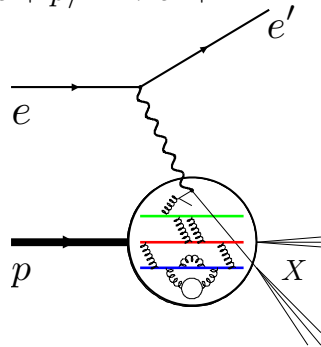

Inclusive DIS

- Inclusive:** Unpolarized $f_i(x, Q^2)$ and helicity distribution $\Delta f_i(x, Q^2)$ functions through unpolarized and polarized structure function measurements (F_2, F_L, g_1)

$$e + p/A \rightarrow e' + h + X$$

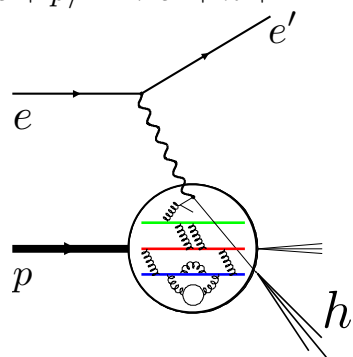

Semi-Inclusive DIS (SIDIS)

- Define kinematics (x, y, Q^2) through electron (e-ID and energy+angular measurement critical) / hadron final state or combination of both depending on kinematic x - Q^2 region

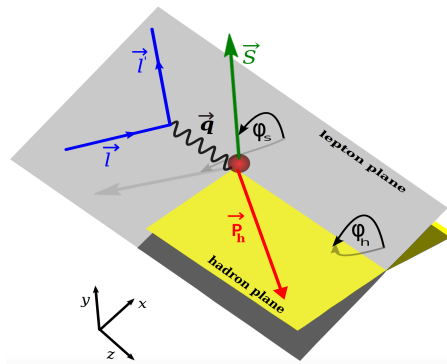

- SIDIS:** Flavor tagging through hadron identification studying FF / TMD's (Transverse momentum, k_T , dependence) requiring azimuthal asymmetry measurement - Full azimuthal acceptance

$$e + p/A \rightarrow e' + N'/A' + \gamma/m$$

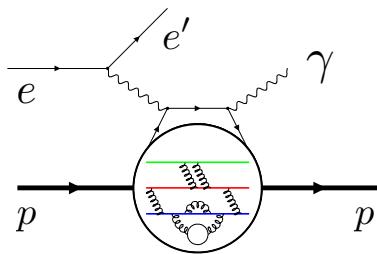

Deeply-Virtual Compton Scattering (DVCS)

- Heavy flavor** (charm / bottom): Excellent secondary vertex reconstruction
- Exclusive:** Tagging of final state proton using Roman pot system studying GPD's (Impact parameter, b_T , dependence) using DVCS and VM production

ePIC Detector Layout

Overview of processes and final states

$$e + p/A \rightarrow e' + X$$

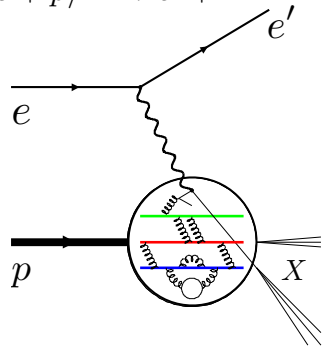

Inclusive DIS

- **Inclusive:** Unpolarized $f_i(x, Q^2)$ and helicity distribution $\Delta f_i(x, Q^2)$ functions through unpolarized and polarized structure function measurements (F_2, F_L, g_1)

$$e + p/A \rightarrow e' + h + X$$

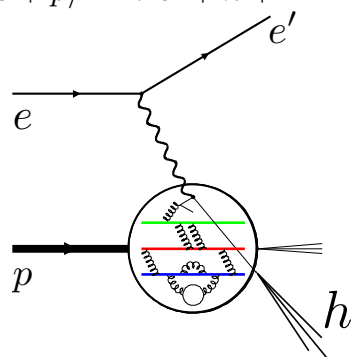

Semi-Inclusive DIS (SDIS)

- Define kinematics (x, y, Q^2) through electron (e-ID and energy+angular measurement critical) / hadron final state or combination of both depending on kinematic x - Q^2 region

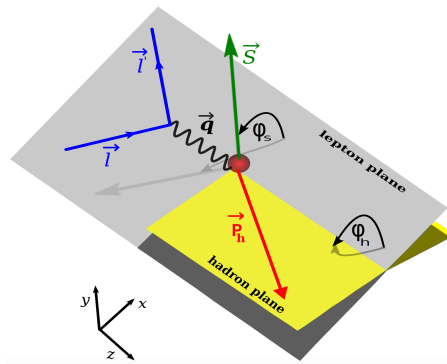

- **SDIS:** Flavor tagging through hadron identification studying FF / TMD's (Transverse momentum, k_T , dependence) requiring azimuthal asymmetry measurement - Full azimuthal acceptance

$$e + p/A \rightarrow e' + N'/A' + \gamma/m$$

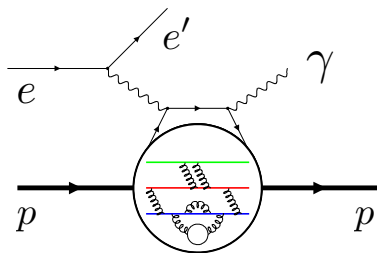

Deeply-Virtual Compton Scattering (DVCS)

- **Heavy flavor** (charm / bottom): Excellent secondary vertex reconstruction

- **Exclusive:** Tagging of final state proton using Roman pot system studying GPD's (Impact parameter, b_T , dependence) using DVCS and VM production
- **eA:** Impact parameter determination / Neutron tagging using Zero-Degree Calorimeter (ZDC)



ePIC Detector Layout

- Overview of general requirements

arXiv:1212.1701

ePIC Detector Layout

□ Overview of general requirements

arXiv:1212.1701

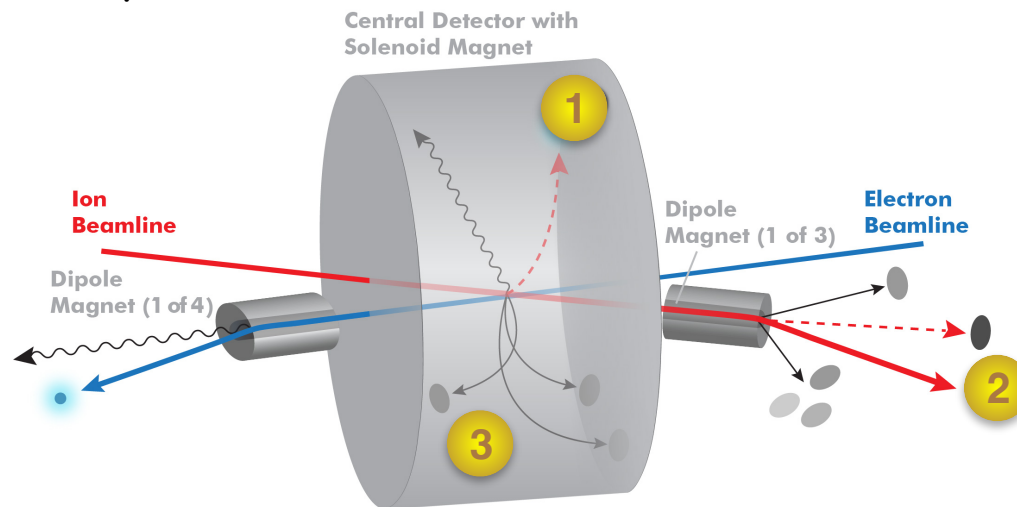

ePIC Detector Layout

□ Overview of general requirements

arXiv:1212.1701

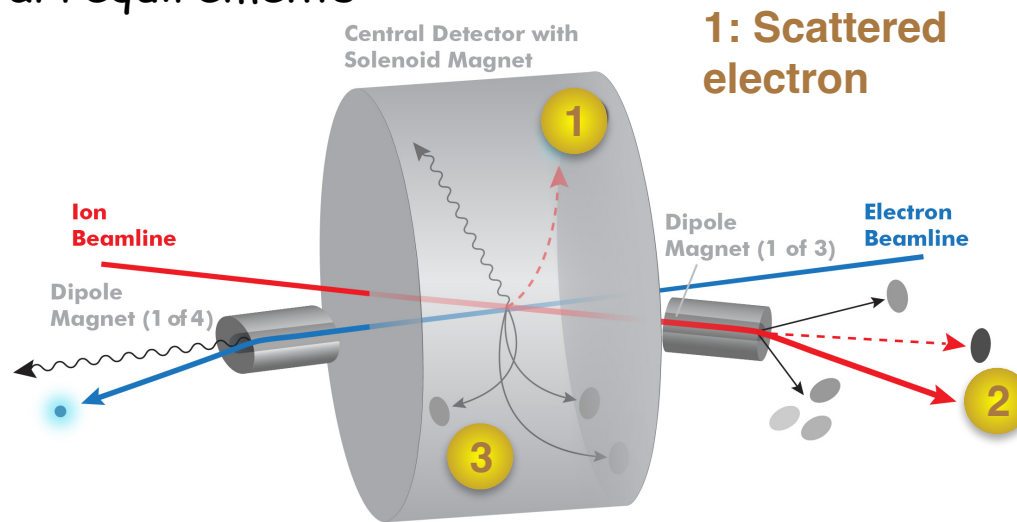

ePIC Detector Layout

□ Overview of general requirements

arXiv:1212.1701

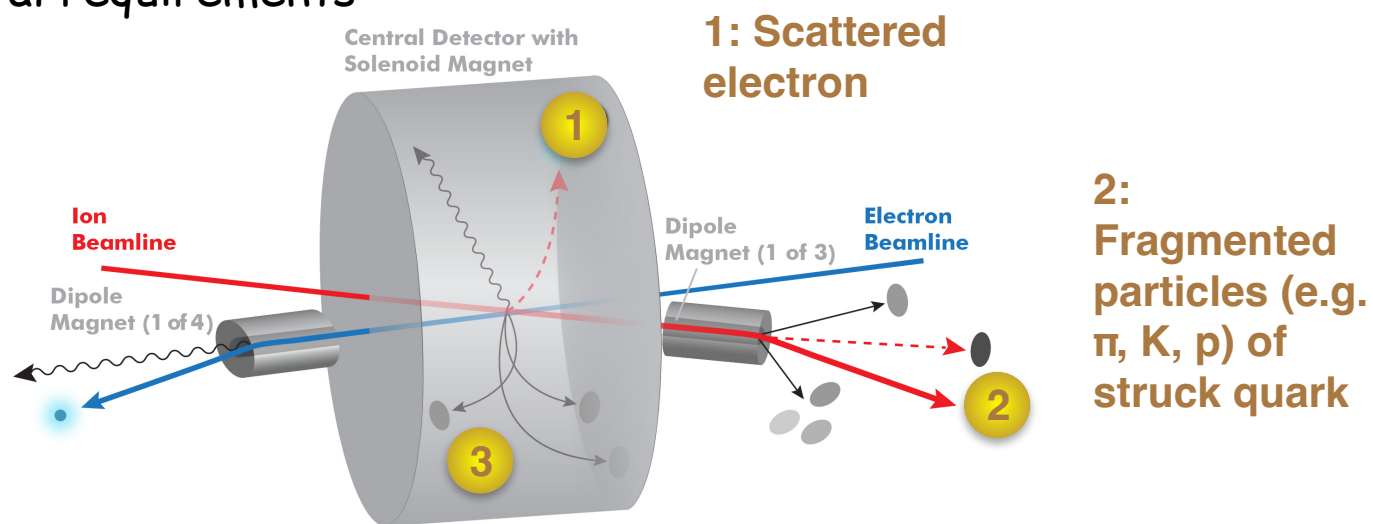

ePIC Detector Layout

□ Overview of general requirements

arXiv:1212.1701

3: Nuclear and nucleonic fragments / scattered proton

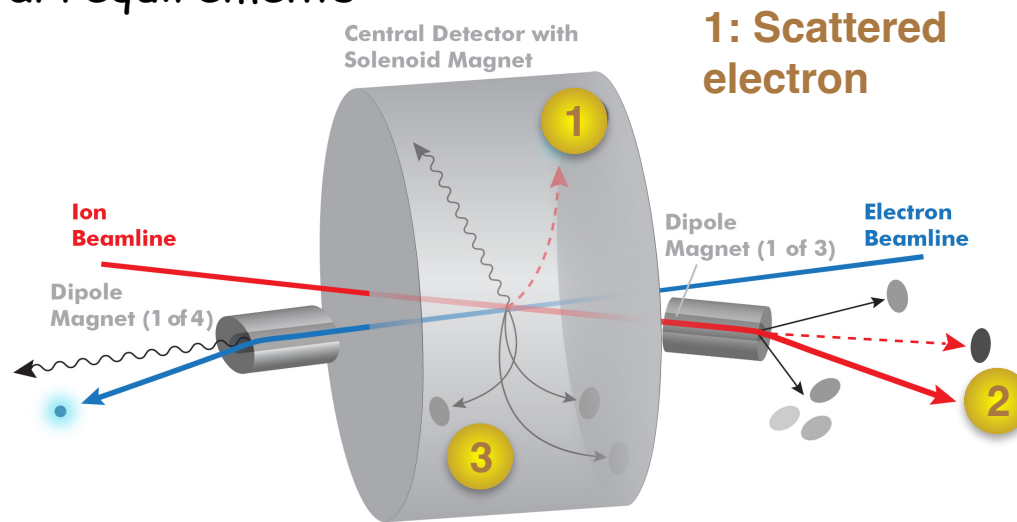

1: Scattered electron

2: Fragmented particles (e.g. π , K, p) of struck quark

ePIC Detector Layout

□ Overview of general requirements

arXiv:1212.1701

3: Nuclear and nucleonic fragments / scattered proton

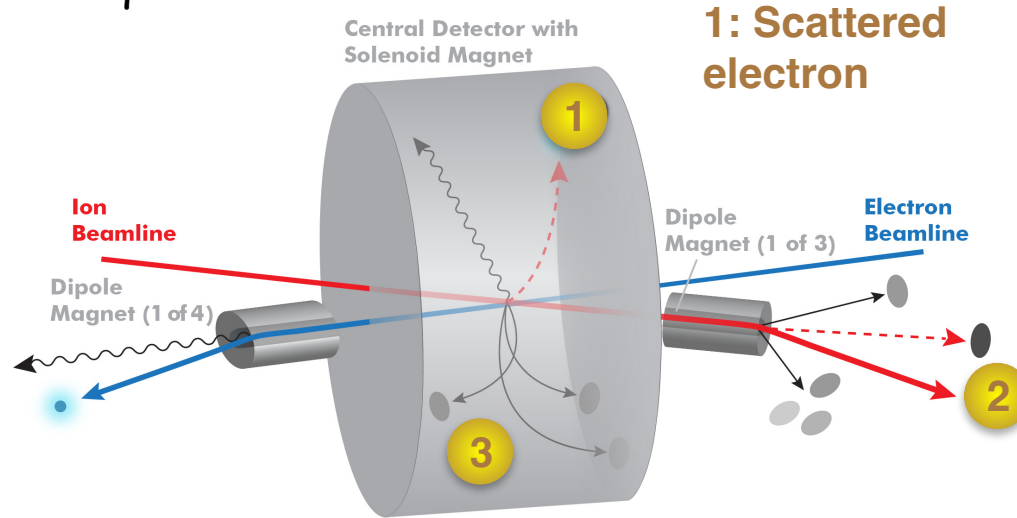

1: Scattered electron

2: Fragmented particles (e.g. π , K, p) of struck quark

- **Acceptance:** Close to 4π coverage with a η -coverage ($\eta = -\ln(\tan(\theta/2))$) of approximately $\eta < |3.5|$ combined calorimetry (EM CAL and hadron CAL at least in forward direction) and tracking coverage

ePIC Detector Layout

□ Overview of general requirements

arXiv:1212.1701

3: Nuclear and nucleonic fragments / scattered proton

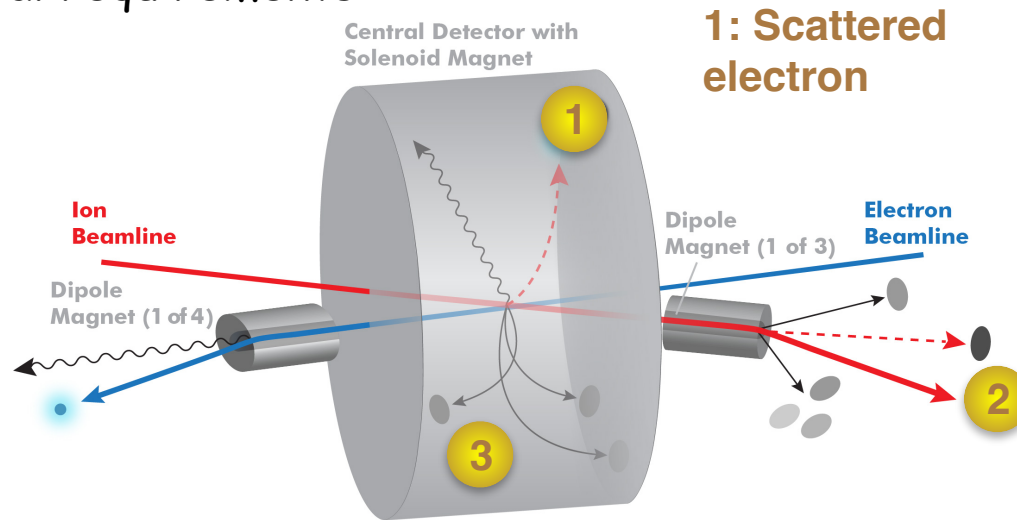

1: Scattered electron

2: Fragmented particles (e.g. π , K, p) of struck quark

- **Acceptance:** Close to 4π coverage with a η -coverage ($\eta = -\ln(\tan(\theta/2))$) of approximately $\eta < |3.5|$ combined calorimetry (EM CAL and hadron CAL at least in forward direction) and tracking coverage
- **Low dead material** budget in particular in rear direction ($\sim 10\% X/X_0$)

ePIC Detector Layout

□ Overview of general requirements

arXiv:1212.1701

3: Nuclear and nucleonic fragments / scattered proton

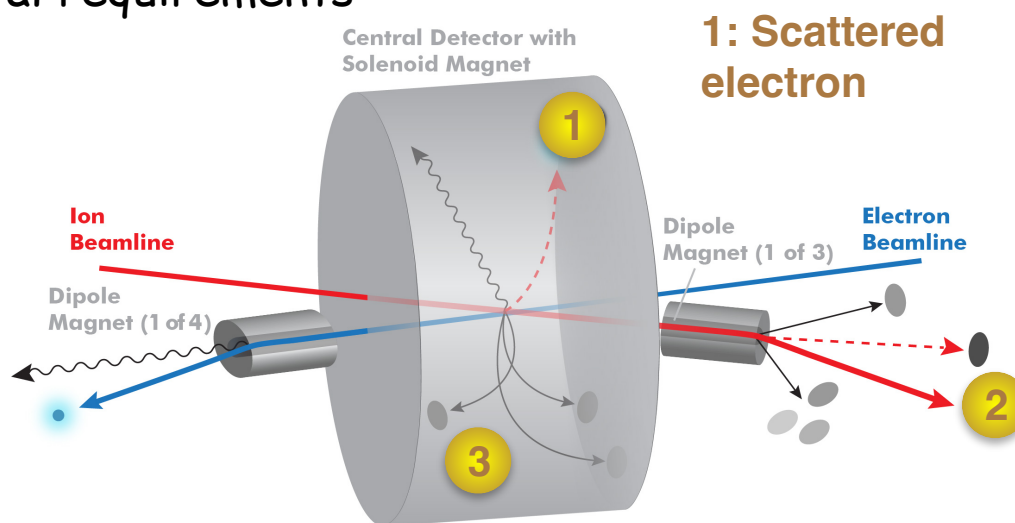

1: Scattered electron

2: Fragmented particles (e.g. π , K, p) of struck quark

- **Acceptance:** Close to 4π coverage with a η -coverage ($\eta = -\ln(\tan(\theta/2))$) of approximately $\eta < |3.5|$ combined calorimetry (EM CAL and hadron CAL at least in forward direction) and tracking coverage
- **Low dead material** budget in particular in rear direction ($\sim 10\% X/X_0$)
- **Good momentum resolution** $\Delta p/p \sim \text{few } \%$

ePIC Detector Layout

□ Overview of general requirements

arXiv:1212.1701

3: Nuclear and nucleonic fragments / scattered proton

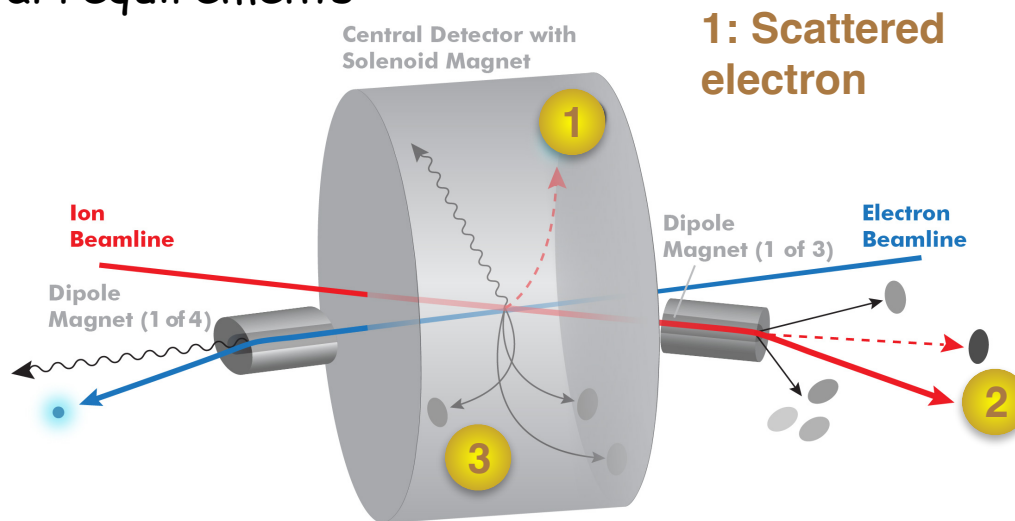

1: Scattered electron

2: Fragmented particles (e.g. π , K, p) of struck quark

- **Acceptance:** Close to 4π coverage with a η -coverage ($\eta = -\ln(\tan(\theta/2))$) of approximately $\eta < |3.5|$ combined calorimetry (EM CAL and hadron CAL at least in forward direction) and tracking coverage
- **Low dead material** budget in particular in rear direction ($\sim 10\% X/X_0$)
- **Good momentum resolution** $\Delta p/p \sim \text{few } \%$
- **Electron ID** for e/h separation varies with θ / η at the level of $1:10^4 / \sim 2\text{-}3\%/\sqrt{E}$ for $\eta < -2$ and $\sim 7\%/\sqrt{E}$ for $-2 < \eta < 1$

ePIC Detector Layout

□ Overview of general requirements

arXiv:1212.1701

3: Nuclear and nucleonic fragments / scattered proton

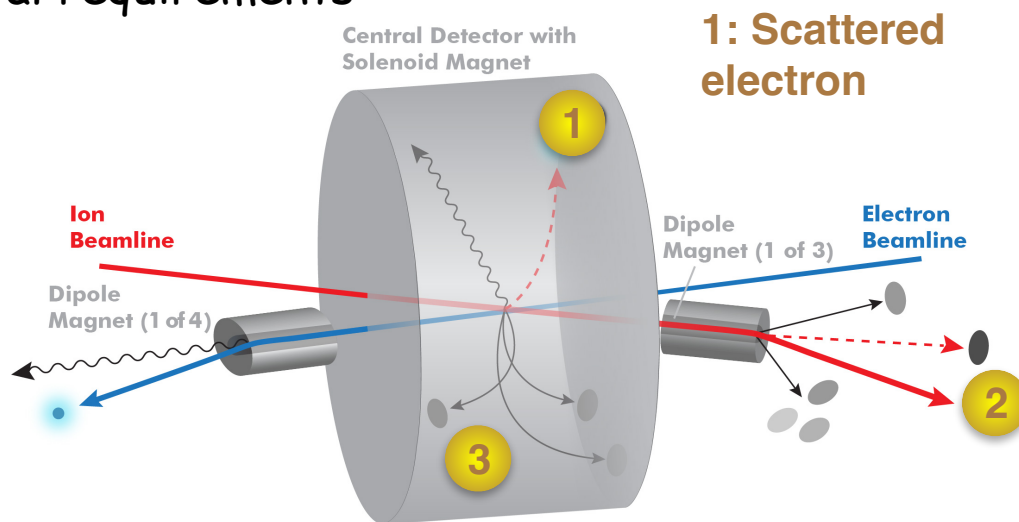

- **Acceptance:** Close to 4π coverage with a η -coverage ($\eta = -\ln(\tan(\theta/2))$) of approximately $\eta < |3.5|$ combined calorimetry (EM CAL and hadron CAL at least in forward direction) and tracking coverage
- **Low dead material** budget in particular in rear direction ($\sim 10\% X/X_0$)
- **Good momentum resolution** $\Delta p/p \sim \text{few } \%$
- **Electron ID** for e/h separation varies with θ / η at the level of $1:10^4 / \sim 2\text{-}3\%/\sqrt{E}$ for $\eta < -2$ and $\sim 7\%/\sqrt{E}$ for $-2 < \eta < 1$

- **Particle ID** for $\pi/K/p$ separation over wide momentum range (Forward η up to $\sim 50\text{GeV}/c$ / Barrel η up to $\sim 4\text{GeV}/c$ / Rear η up to $\sim 6\text{GeV}/c$)
- **High spatial vertex resolution** $\sim 10\text{-}20\mu\text{m}$ for vertex reconstruction

ePIC Detector Layout

□ Overview of general requirements

arXiv:1212.1701

3: Nuclear and nucleonic fragments / scattered proton

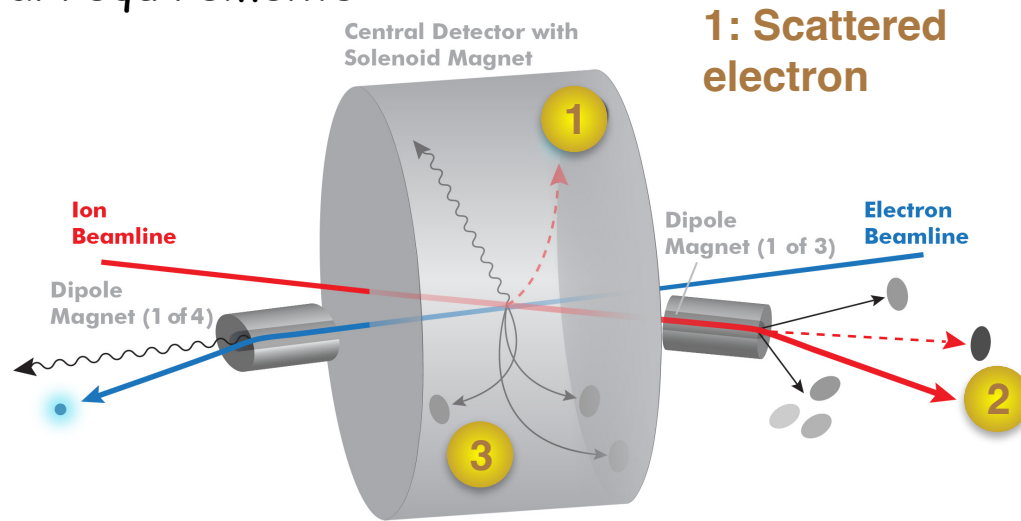

1: Scattered electron

2: Fragmented particles (e.g. π , K, p) of struck quark

- **Acceptance:** Close to 4π coverage with a η -coverage ($\eta = -\ln(\tan(\theta/2))$) of approximately $\eta < |3.5|$ combined calorimetry (EM CAL and hadron CAL at least in forward direction) and tracking coverage
- **Low dead material** budget in particular in rear direction ($\sim 10\% X/X_0$)
- **Good momentum resolution** $\Delta p/p \sim \text{few } \%$
- **Electron ID** for e/h separation varies with θ / η at the level of $1:10^4 / \sim 2\text{-}3\%/\sqrt{E}$ for $\eta < -2$ and $\sim 7\%/\sqrt{E}$ for $-2 < \eta < 1$

- **Particle ID** for $\pi/K/p$ separation over wide momentum range (Forward η up to $\sim 50\text{GeV}/c$ / Barrel η up to $\sim 4\text{GeV}/c$ / Rear η up to $\sim 6\text{GeV}/c$)
- **High spatial vertex resolution** $\sim 10\text{-}20\mu\text{m}$ for vertex reconstruction
- **Low-angle taggers:**

ePIC Detector Layout

□ Overview of general requirements

arXiv:1212.1701

3: Nuclear and nucleonic fragments / scattered proton

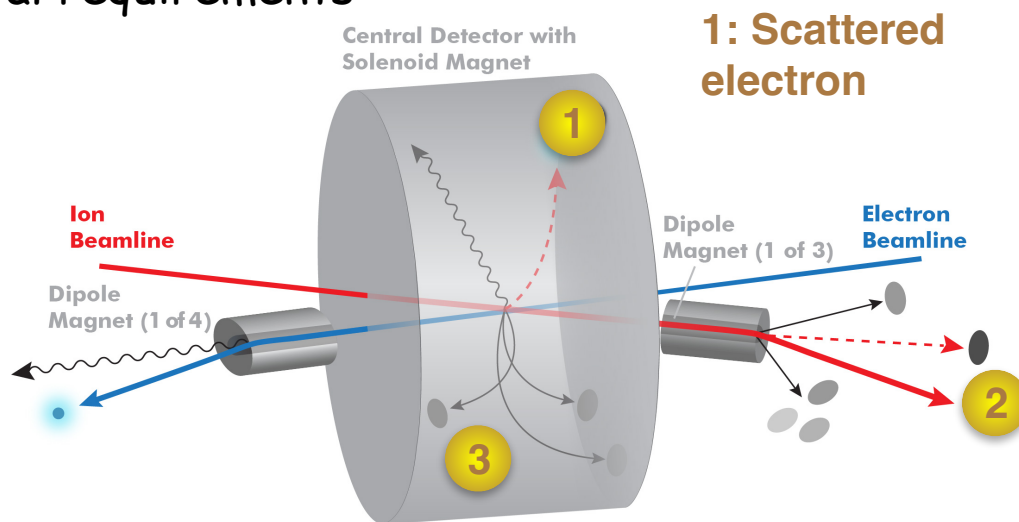

1: Scattered electron

2: Fragmented particles (e.g. π , K, p) of struck quark

- **Acceptance:** Close to 4π coverage with a η -coverage ($\eta = -\ln(\tan(\theta/2))$) of approximately $\eta < |3.5|$ combined calorimetry (EM CAL and hadron CAL at least in forward direction) and tracking coverage
- **Low dead material** budget in particular in rear direction ($\sim 10\% X/X_0$)
- **Good momentum resolution** $\Delta p/p \sim \text{few } \%$
- **Electron ID** for e/h separation varies with θ / η at the level of $1:10^4 / \sim 2\text{-}3\%/\sqrt{E}$ for $\eta < -2$ and $\sim 7\%/\sqrt{E}$ for $-2 < \eta < 1$

- **Particle ID** for $\pi/K/p$ separation over wide momentum range (Forward η up to $\sim 50\text{GeV}/c$ / Barrel η up to $\sim 4\text{GeV}/c$ / Rear η up to $\sim 6\text{GeV}/c$)
- **High spatial vertex resolution** $\sim 10\text{-}20\mu\text{m}$ for vertex reconstruction
- **Low-angle taggers:**
 - Forward proton / A fragment spectrometer (Roman pots)

ePIC Detector Layout

□ Overview of general requirements

arXiv:1212.1701

3: Nuclear and nucleonic fragments / scattered proton

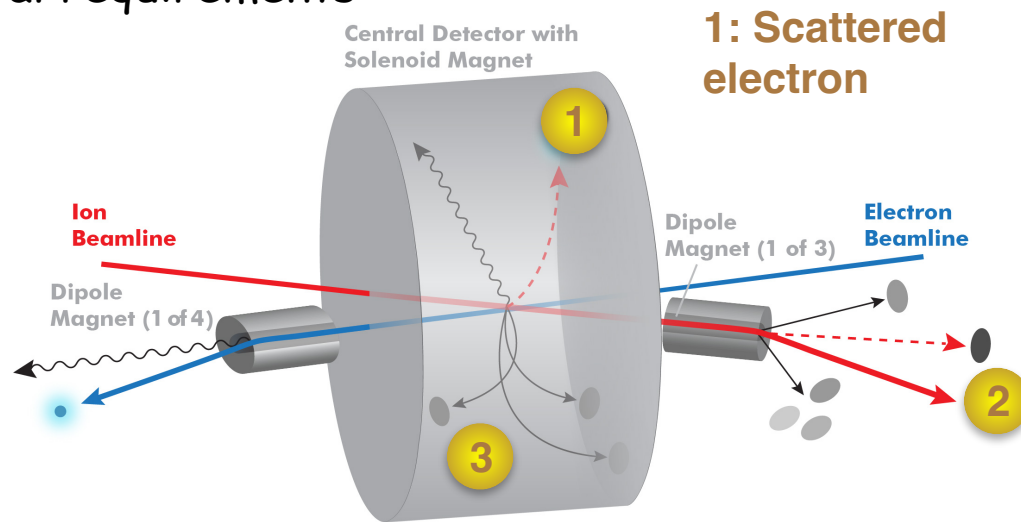

- **Acceptance:** Close to 4π coverage with a η -coverage ($\eta = -\ln(\tan(\theta/2))$) of approximately $\eta < |3.5|$ combined calorimetry (EM CAL and hadron CAL at least in forward direction) and tracking coverage
- **Low dead material** budget in particular in rear direction ($\sim 10\% X/X_0$)
- **Good momentum resolution** $\Delta p/p \sim \text{few } \%$
- **Electron ID** for e/h separation varies with θ / η at the level of $1:10^4 / \sim 2\text{-}3\%/\sqrt{E}$ for $\eta < -2$ and $\sim 7\%/\sqrt{E}$ for $-2 < \eta < 1$

- **Particle ID** for $\pi/K/p$ separation over wide momentum range (Forward η up to $\sim 50\text{GeV}/c$ / Barrel η up to $\sim 4\text{GeV}/c$ / Rear η up to $\sim 6\text{GeV}/c$)
- **High spatial vertex resolution** $\sim 10\text{-}20\mu\text{m}$ for vertex reconstruction
- **Low-angle taggers:**
 - Forward proton / A fragment spectrometer (Roman pots)
 - Low Q^2 tagger

ePIC Detector Layout

□ Overview of general requirements

arXiv:1212.1701

3: Nuclear and nucleonic fragments / scattered proton

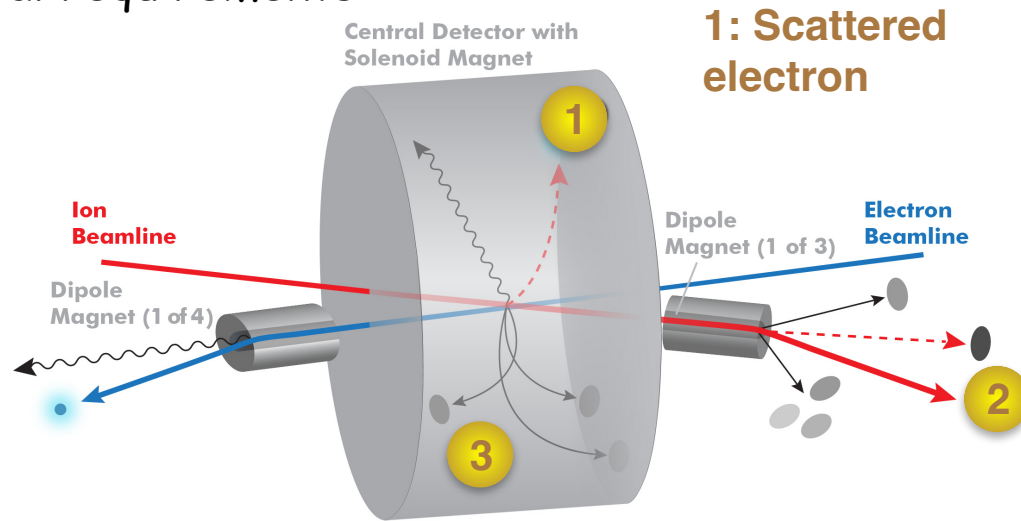

- **Acceptance:** Close to 4π coverage with a η -coverage ($\eta = -\ln(\tan(\theta/2))$) of approximately $\eta < |3.5|$ combined calorimetry (EM CAL and hadron CAL at least in forward direction) and tracking coverage
- **Low dead material** budget in particular in rear direction ($\sim 10\% X/X_0$)
- **Good momentum resolution** $\Delta p/p \sim \text{few } \%$
- **Electron ID** for e/h separation varies with θ / η at the level of $1:10^4 / \sim 2\text{-}3\%/\sqrt{E}$ for $\eta < -2$ and $\sim 7\%/\sqrt{E}$ for $-2 < \eta < 1$

- **Particle ID** for $\pi/K/p$ separation over wide momentum range (Forward η up to $\sim 50\text{GeV}/c$ / Barrel η up to $\sim 4\text{GeV}/c$ / Rear η up to $\sim 6\text{GeV}/c$)
- **High spatial vertex resolution** $\sim 10\text{-}20\mu\text{m}$ for vertex reconstruction
- **Low-angle taggers:**
 - Forward proton / A fragment spectrometer (Roman pots)
 - Low Q^2 tagger
 - Neutrons on hadron direction

ePIC Detector Layout

□ Overview of general requirements

arXiv:1212.1701

3: Nuclear and nucleonic fragments / scattered proton

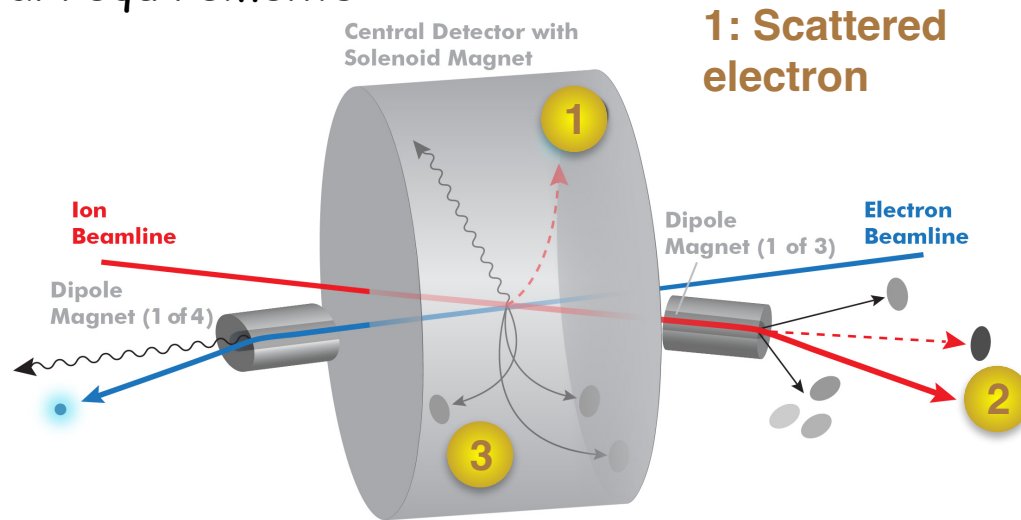

- **Acceptance:** Close to 4π coverage with a η -coverage ($\eta = -\ln(\tan(\theta/2))$) of approximately $\eta < |3.5|$ combined calorimetry (EM CAL and hadron CAL at least in forward direction) and tracking coverage
- **Low dead material** budget in particular in rear direction ($\sim 10\% X/X_0$)
- **Good momentum resolution** $\Delta p/p \sim \text{few } \%$
- **Electron ID** for e/h separation varies with θ / η at the level of $1:10^4 / \sim 2\text{-}3\%/\sqrt{E}$ for $\eta < -2$ and $\sim 7\%/\sqrt{E}$ for $-2 < \eta < 1$

- **Particle ID** for $\pi/K/p$ separation over wide momentum range (Forward η up to $\sim 50\text{GeV}/c$ / Barrel η up to $\sim 4\text{GeV}/c$ / Rear η up to $\sim 6\text{GeV}/c$)
- **High spatial vertex resolution** $\sim 10\text{-}20\mu\text{m}$ for vertex reconstruction
- **Low-angle taggers:**
 - Forward proton / A fragment spectrometer (Roman pots)
 - Low Q^2 tagger
 - Neutrons on hadron direction
- **Luminosity** (Absolute and relative) and **local polarization direction measurement**

ePIC Detector Layout

□ Global ePIC design overview

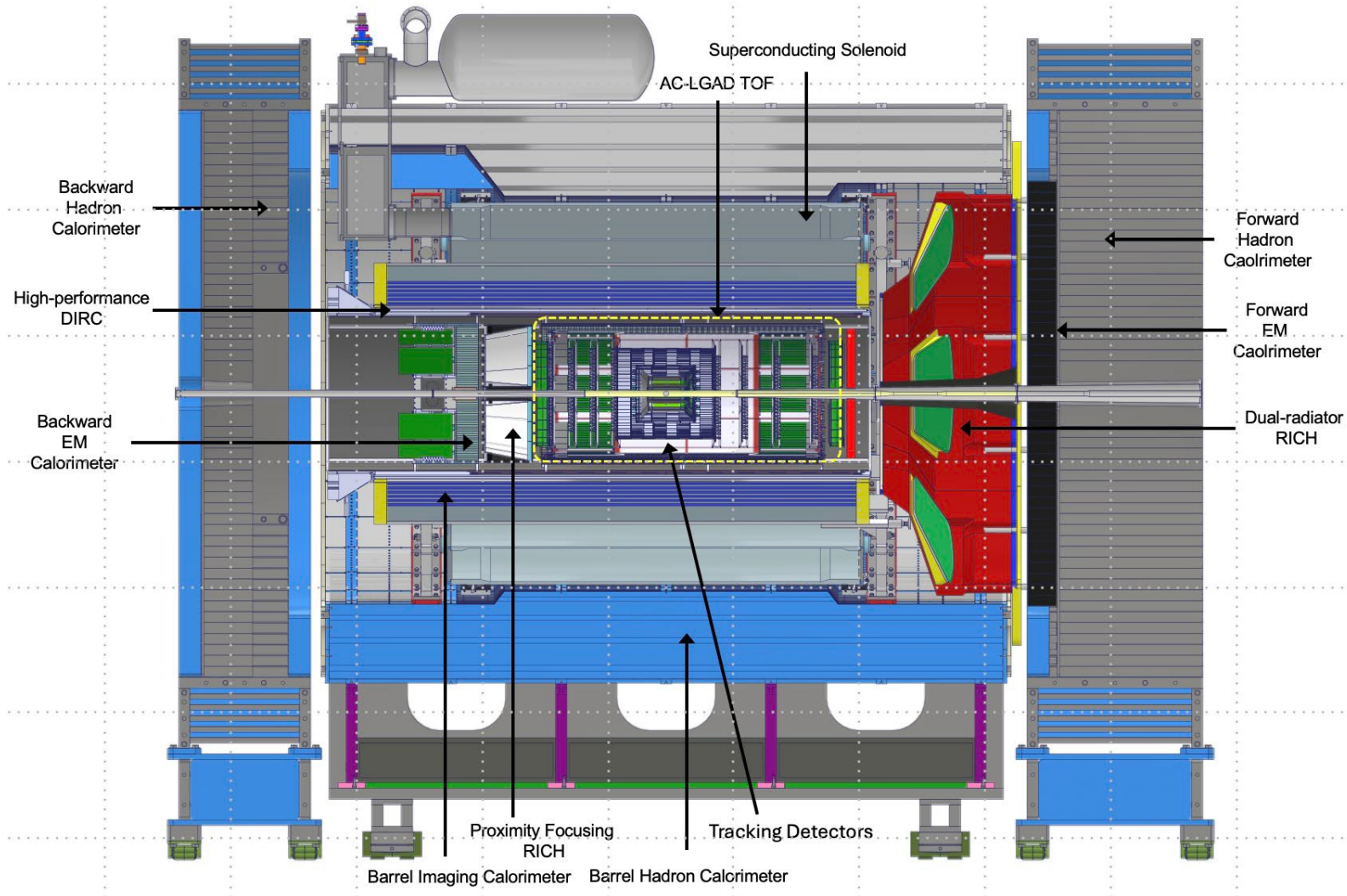



ePIC Detector Layout

- Global ePIC design overview

ePIC Detector Layout

□ Global ePIC design overview

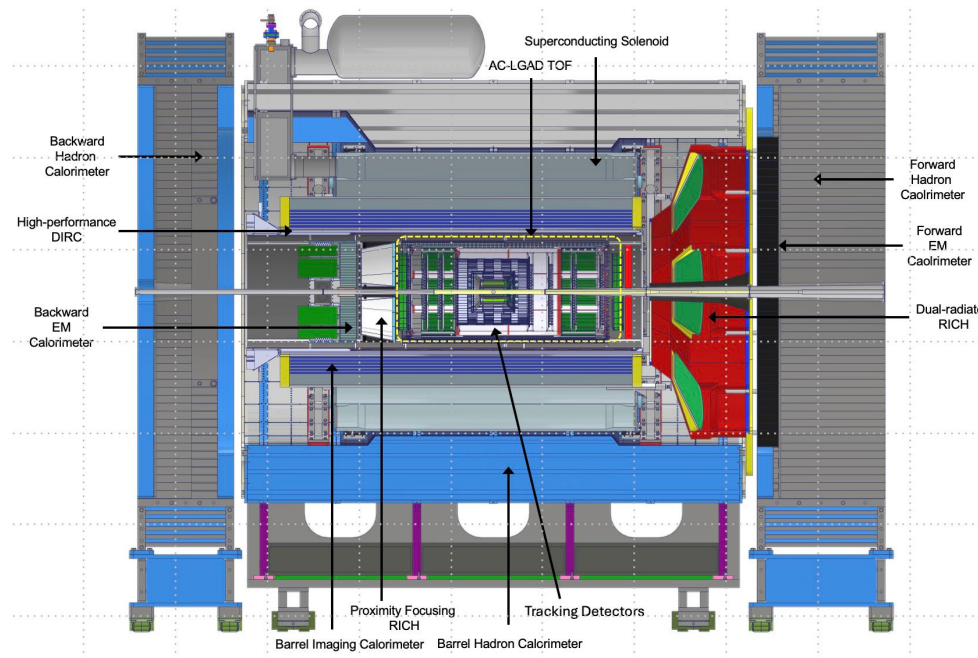

ePIC Detector Layout

Global ePIC design overview

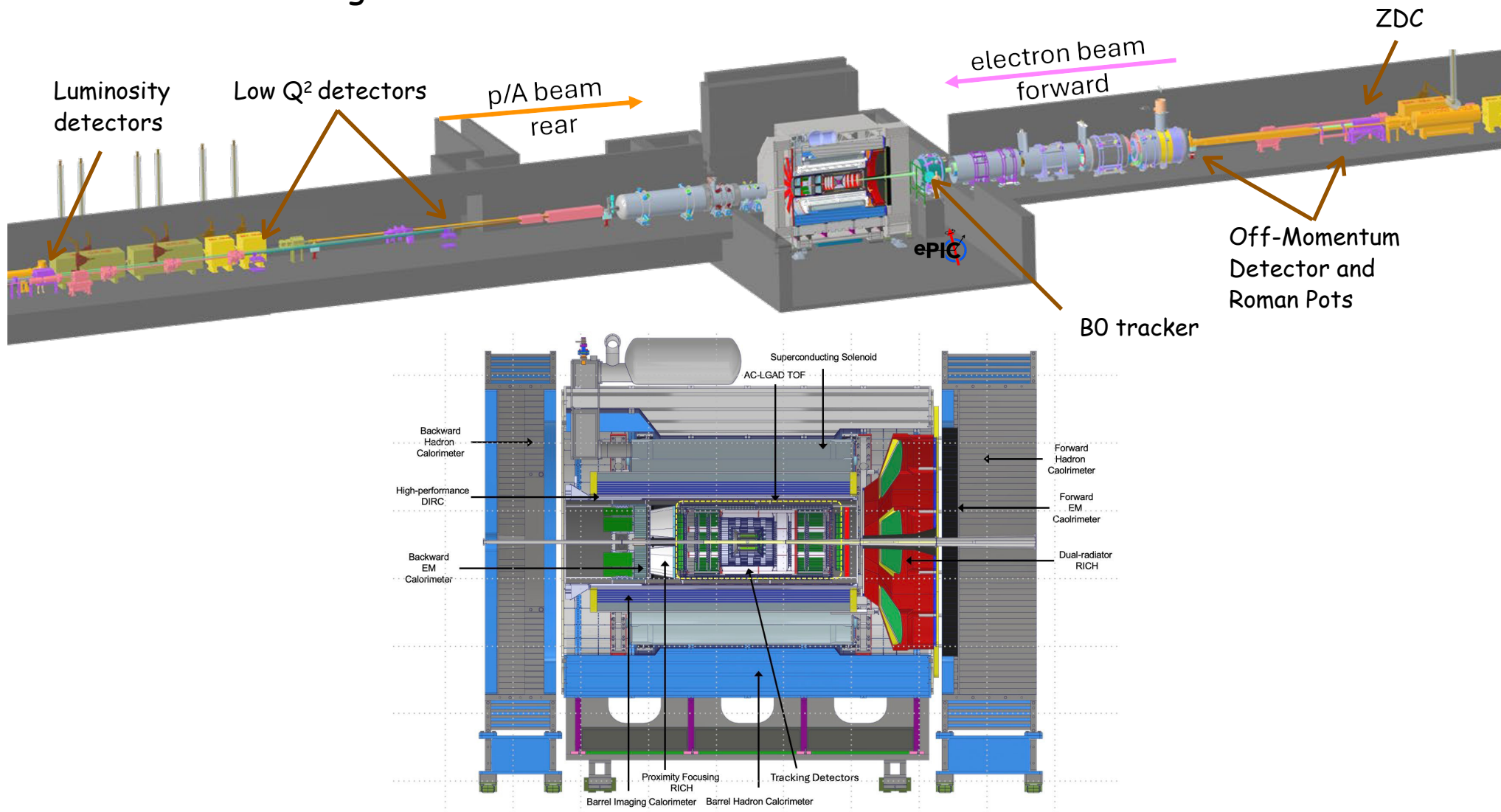

ePIC Detector Layout

ePIC Detector Design

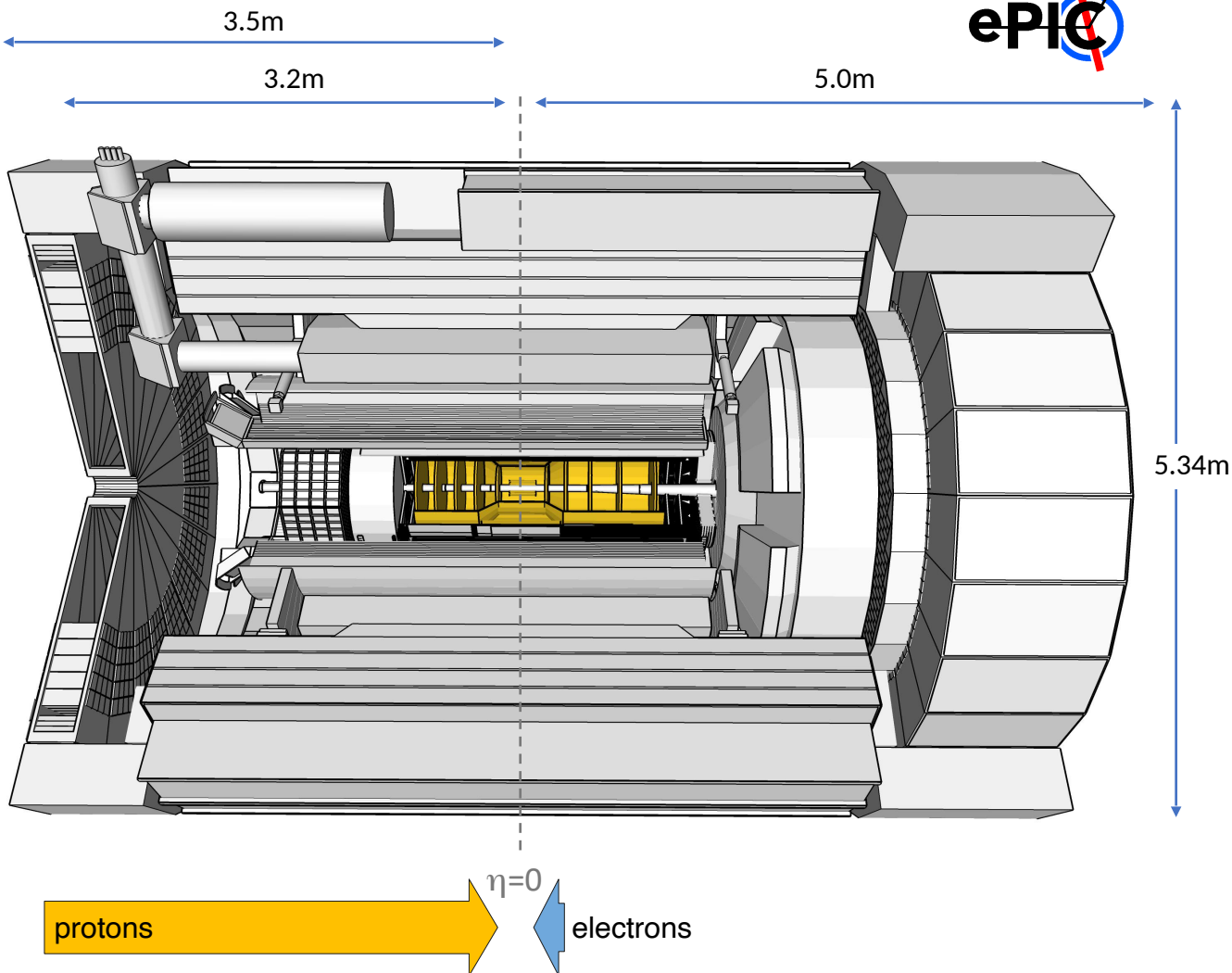

Tracking:

- New 1.7T solenoid
- Si MAPS Tracker
- MPGDs (μ RWELL/ μ Megas)

PID:

- hpDIRC
- pFRICH
- dRICH
- AC-LGAD (~ 30 ps TOF)

Calorimetry:

- Imaging Barrel EMCal
- PbWO₄ EMCal in backward direction
- Finely segmented EMCal +HCal in forward direction
- Outer HCal (sPHENIX reuse)
- Backwards HCal (tail-catcher)

ePIC Detector Layout

ePIC Detector Design

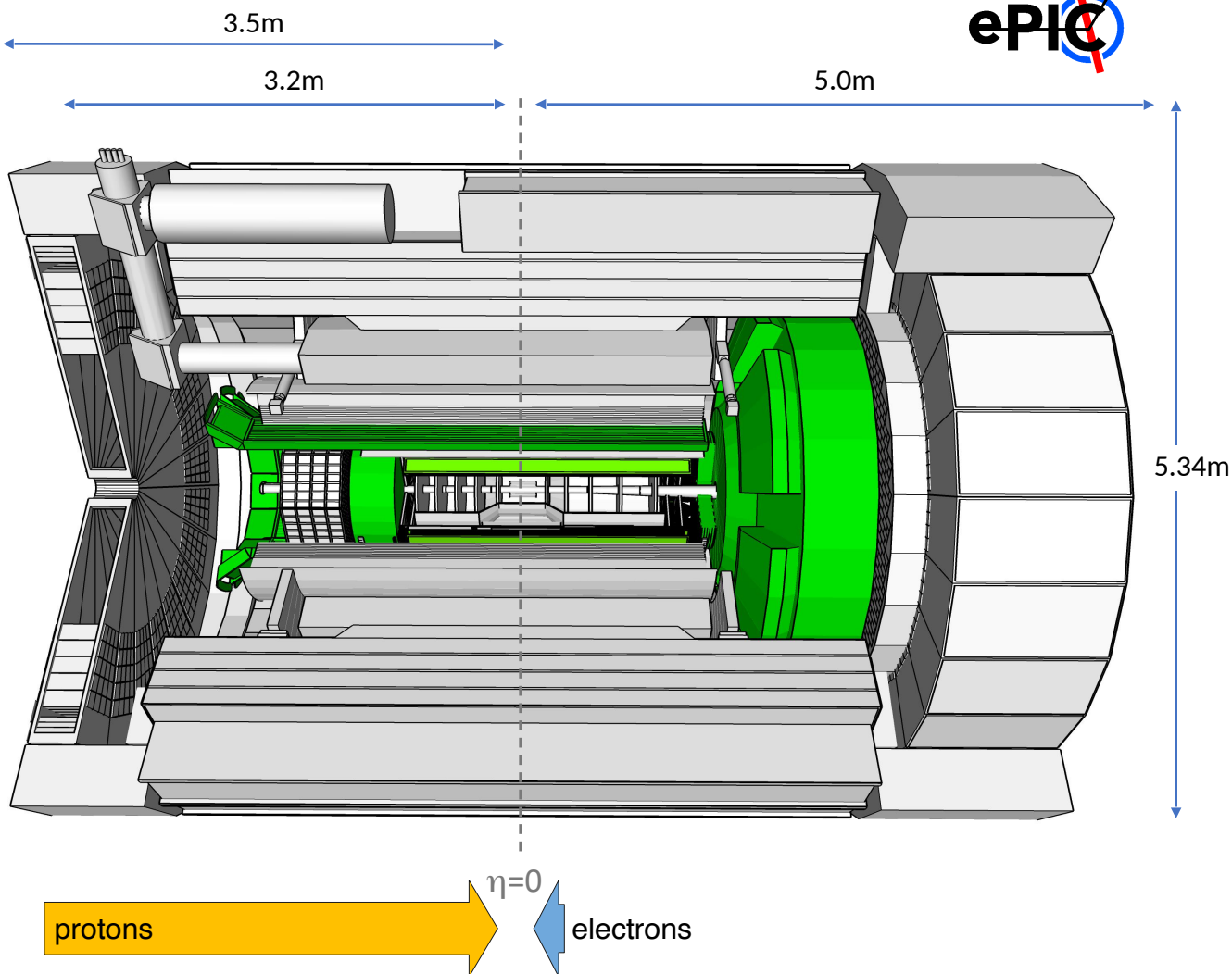

Tracking:

- New 1.7T solenoid
- Si MAPS Tracker
- MPGDs (μ RWELL/ μ Megas)

PID:

- hpDIRC
- pFRICH
- dRICH
- AC-LGAD (~ 30 ps TOF)

Calorimetry:

- Imaging Barrel EMCal
- PbWO₄ EMCal in backward direction
- Finely segmented EMCal +HCal in forward direction
- Outer HCal (sPHENIX reuse)
- Backwards HCal (tail-catcher)

ePIC Detector Layout

ePIC Detector Design

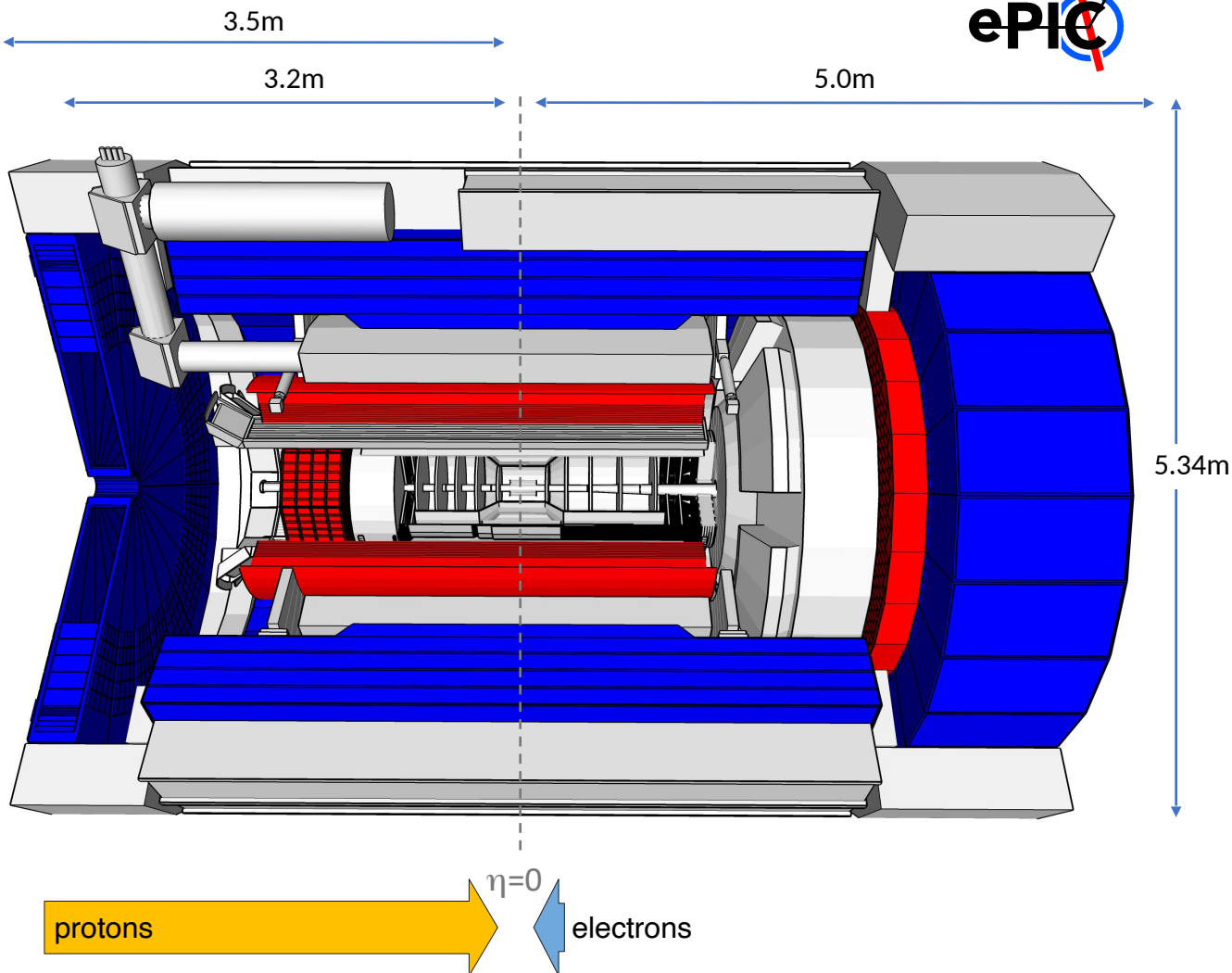

Tracking:

- New 1.7T solenoid
- Si MAPS Tracker
- MPGDs (μ RWELL/ μ Megas)

PID:

- hpDIRC
- pFRICH
- dRICH
- AC-LGAD (~ 30 ps TOF)

Calorimetry:

- Imaging Barrel EMCal
- PbWO₄ EMCal in backward direction
- Finely segmented EMCal +HCal in forward direction
- Outer HCal (sPHENIX reuse)
- Backwards HCal (tail-catcher)

ePIC Detector Layout

□ ePIC Tracking Detectors: Layout

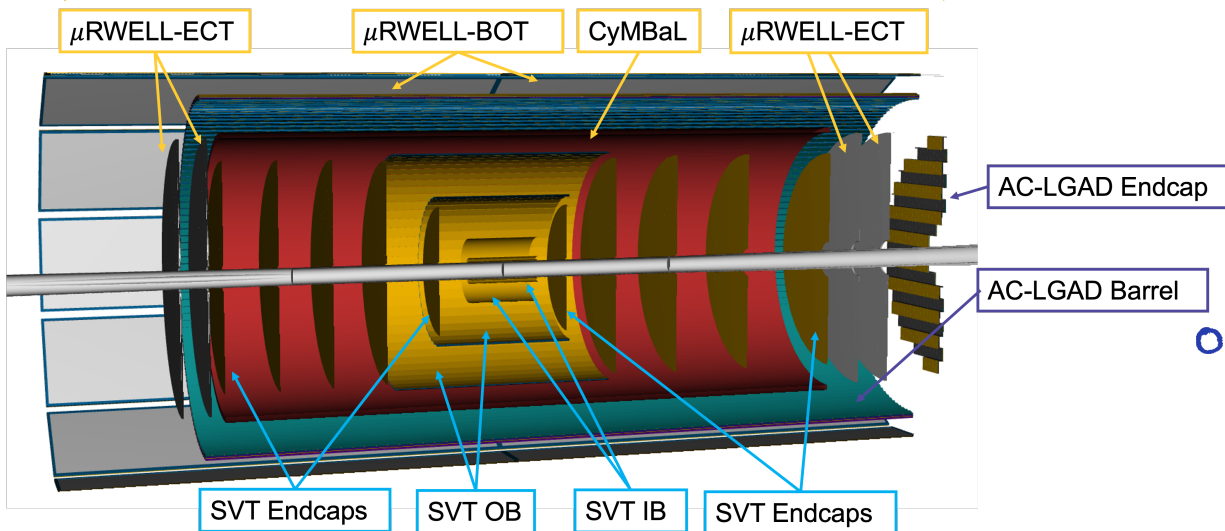
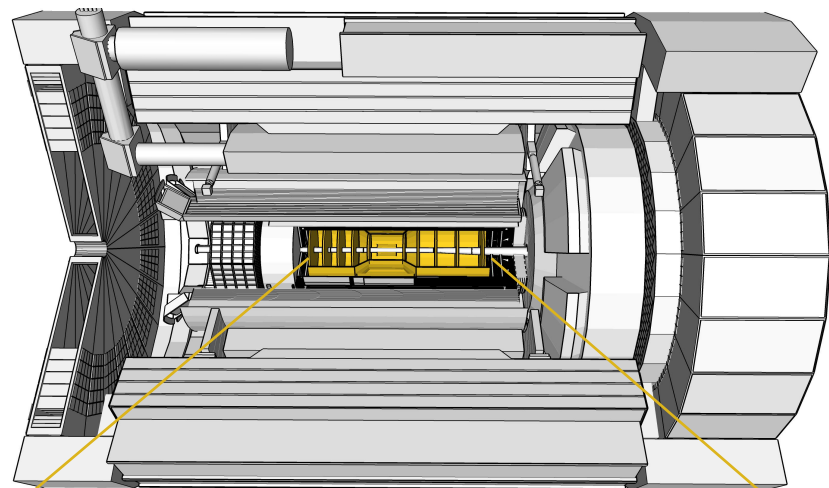

○ MAPS Tracker:

- Small pixels ($20\ \mu\text{m}$), low power consumption ($<20\ \text{mW}/\text{cm}^2$) and material budget (0.05% to $0.55\% X/X_0$) per layer
- Based on ALICE ITS3 development
- Vertex layers optimized for beam pipe bake-out and ITS-3 sensor size
- Forward and backward disks

○ MPGD Layers:

- Provide timing and pattern recognition
- Cylindrical μ MEGAs
- Planar μ RWell's before hpDIRC - Impact point and direction for ring seeding

○ AC-LGAD TOF and AstroPix (BECAL):

- Additional space point for pattern recognition / redundancy
- Fast hit point / Low p PID

ePIC Detector Layout

ePIC Tracking Detectors: Performance

Technology:

ITS3 MAPS based Si-detectors:

- $O(20\ \mu\text{m})$ pitch, $X/X_0 \sim 0.05 - 0.55\%/ \text{layer}$

Gaseous tracker:

- $\sigma = 150\ \mu\text{m}$, $X/X_0 \sim 0.5 - 2.0\%/ \text{layer}$

AstroPix outer tracker layer:

- $500\ \mu\text{m}$ pixel pitch ($\sigma = 144\ \mu\text{m}$)

First "μITS3" assembly at CERN

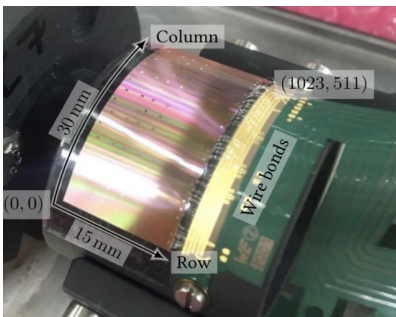

Cylindrical MicroMegas detector

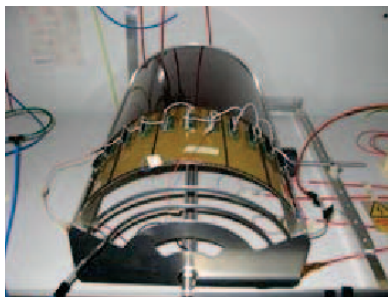

Simulated performance:

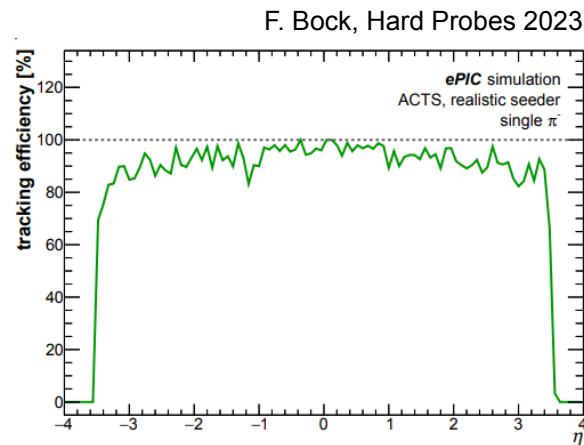

- Meets EICUG Yellow Report design requirements
- Backward momentum resolution complemented by calorimetric resolution

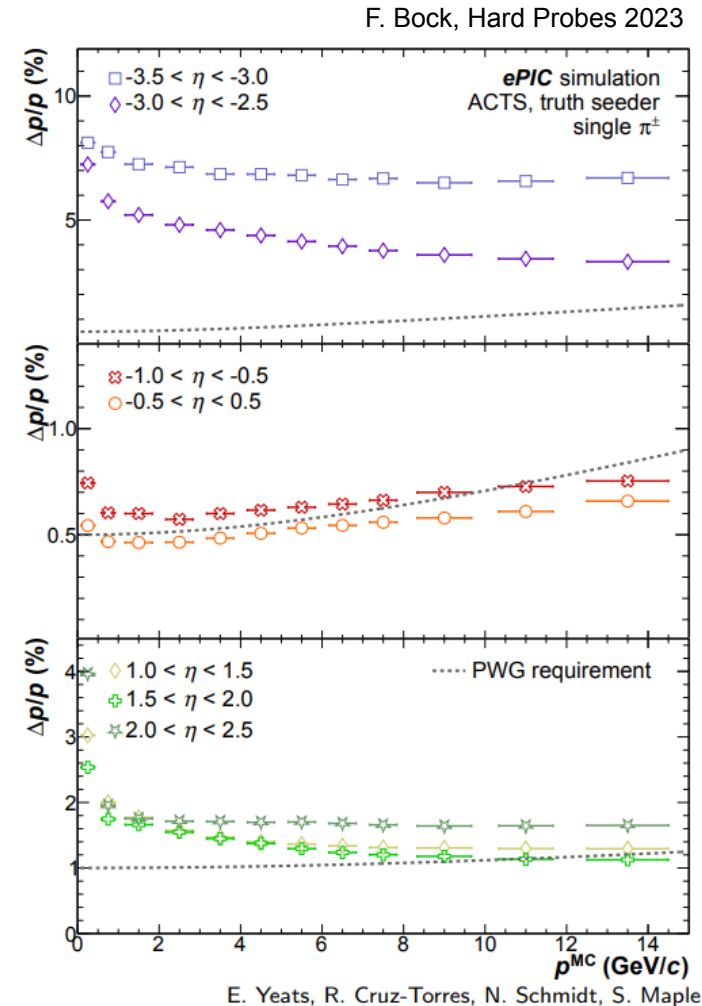

E. Yeats, R. Cruz-Torres, N. Schmidt, S. Maple

Bernd Surrow

ePIC Detector Layout

ePIC Calorimeter Detectors: Layout

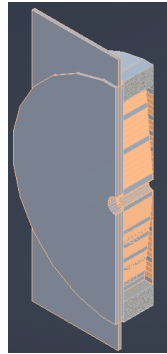

Backwards
HCal
Steel/Sc
Sandwich
tail catcher

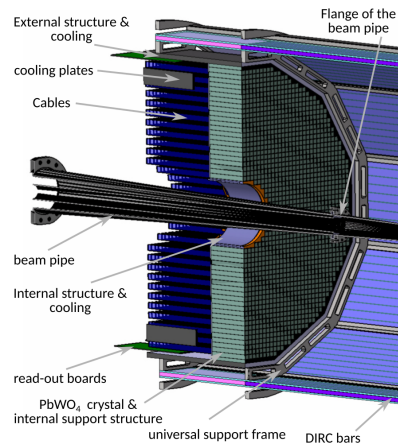

Backwards EMCal
PbWO₄ crystals,
SiPM photosensor

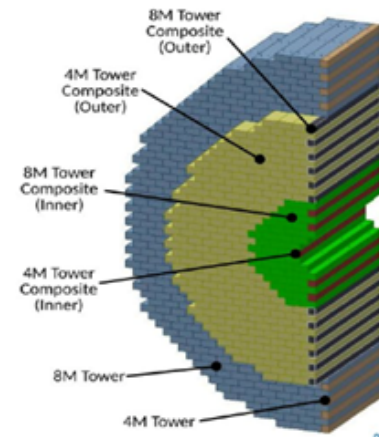
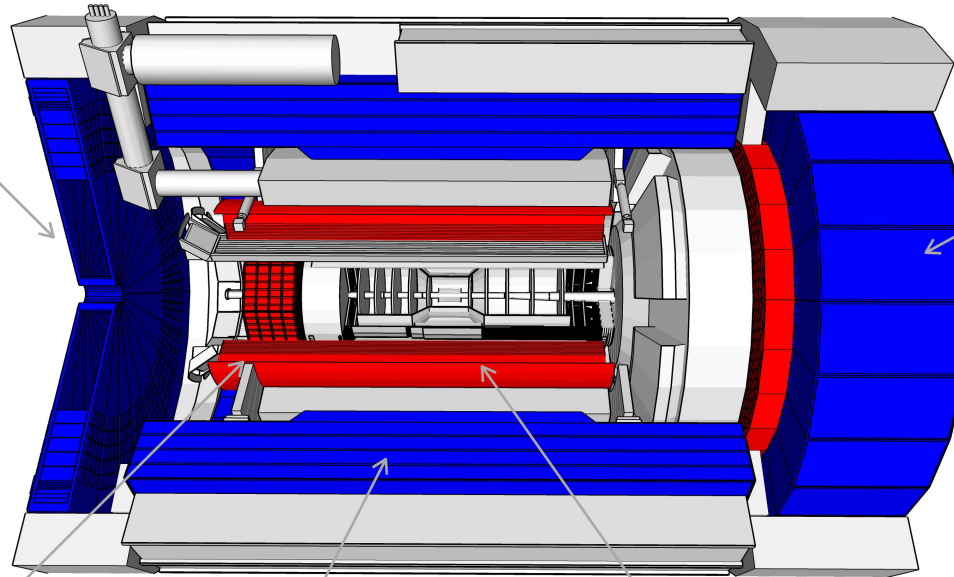

High granularity
W/SciFi EMCAL
Longitudinally separated
HCAL with high- η insert



Barrel HCal
(sPHENIX re-use)

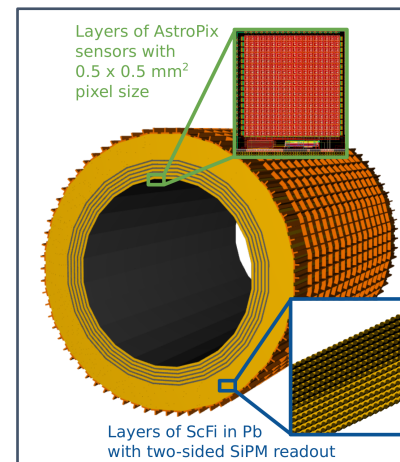

Barrel BECAL

AstroPix v3: Design and Fabrication

Pixel Matrix:

- 500 μ m² Pixel Pitch, 300 μ m² Pixel Size
- 35 x 35 pixels
- first 3 cols PMOS amplifier others NMOS
- Pixel Comparator Outputs Row/Column OR wired
- Goal:
 - Pixel Dynamic Range 20keV - 700keV
 - Noise Floor 5 keV (2% @ 662keV)

ASTROPiX

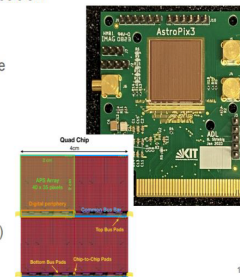

ePIC Detector Layout

ePIC Calorimeter Detectors: Performance

N. Schmidt

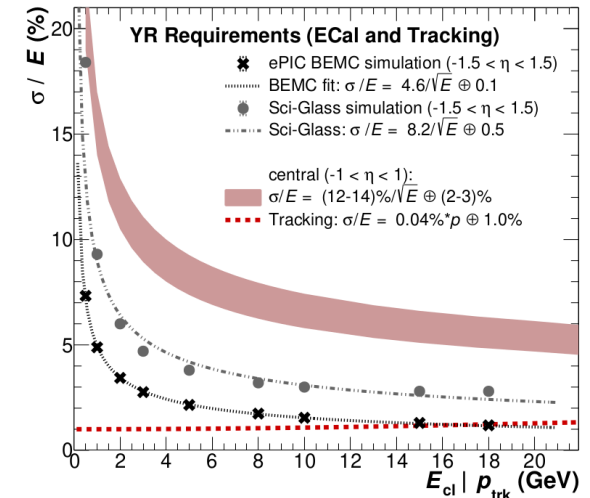
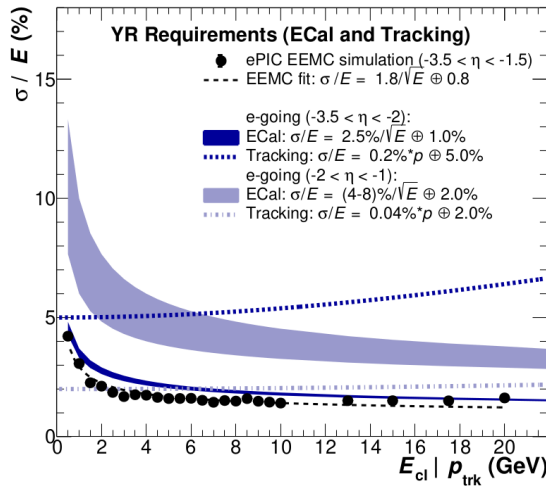
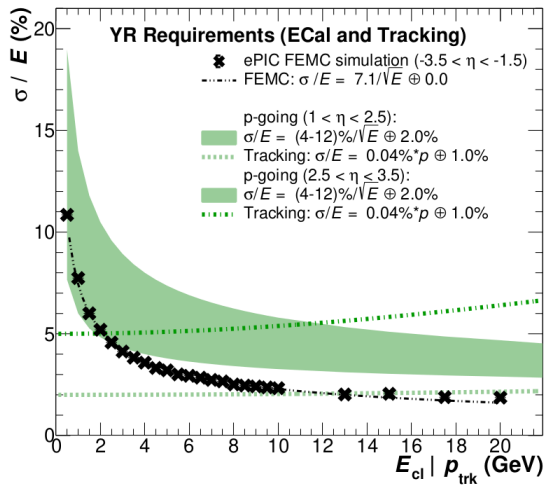

F. Bock, Hard Probes 2023

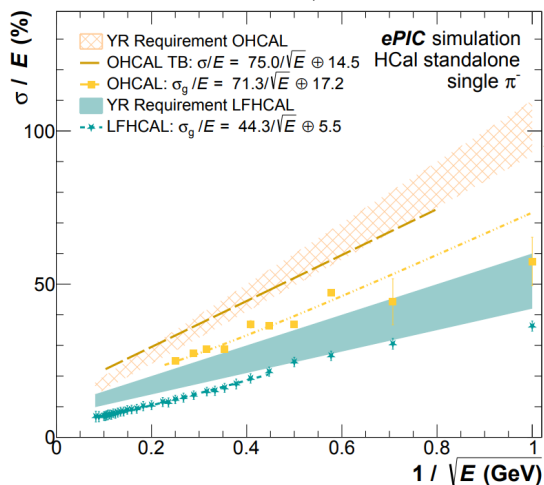

Performance on **energy resolution** and matching:

- Technologies fulfill YR requirements for energy resolution
- Ongoing simulation studies related to overlaps between different η regions for calorimetry and reconstruction algorithms

Ongoing work on Monte-Carlo validation:

- Validation for high Z absorbers

ePIC Detector Layout

ePIC PID Detectors: Layout

High-Performance DIRC

- Quartz bar radiator (BaBAR bars)
- light detection with MCP-PMTs
- Fully focused
- π/K 36 separation at 6 GeV/c

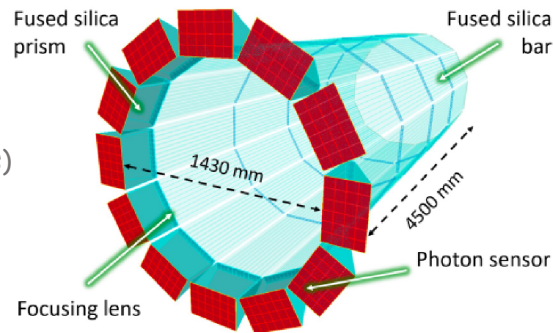

Dual-Radiator RICH (dRICH)

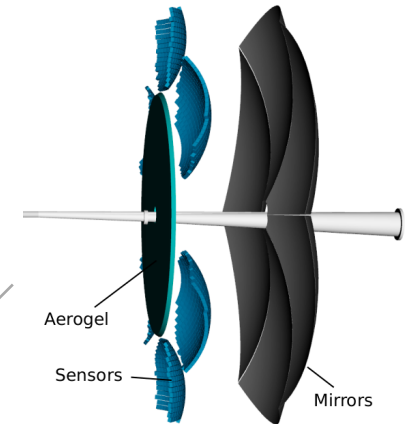

- C_2F_6 Gas Volume and Aerogel
- Sensors tiled on spheres (SiPMs)
- π/K 3 σ sep. at 50 GeV/c

Proximity Focused (pFRICH)

- Long proximity gap (~40 cm)
- Sensor: LAPPDs
- up to 9 GeV/c 36 π/K sep.

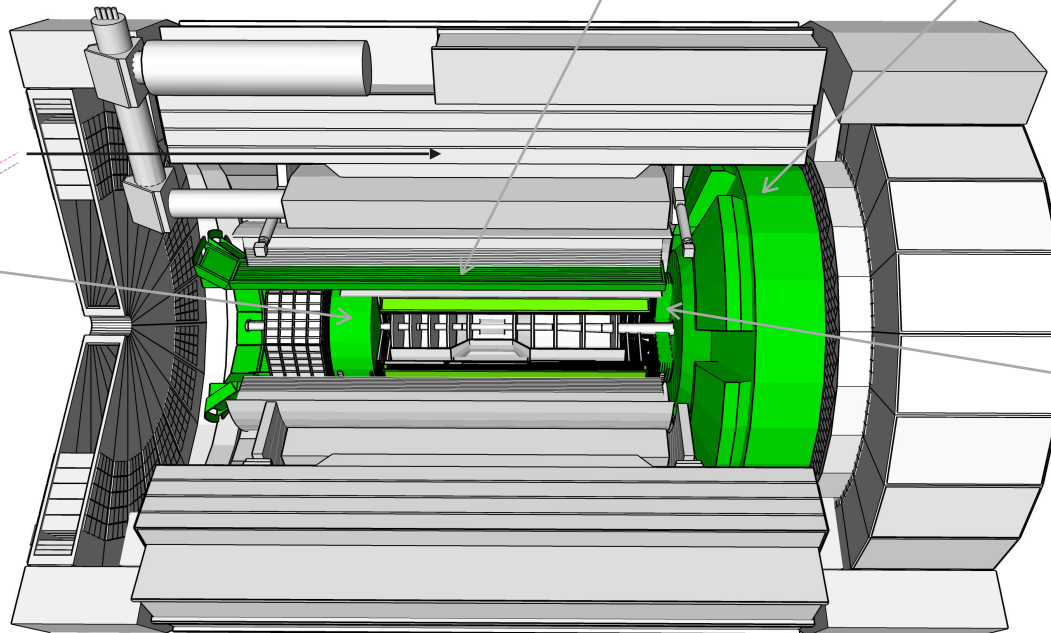
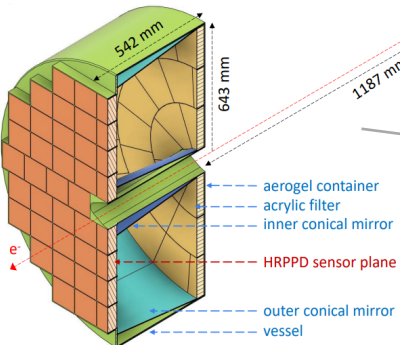

AC-LGAD TOF (~30ps)

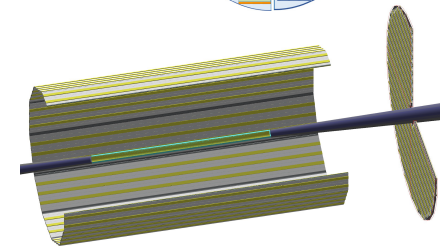
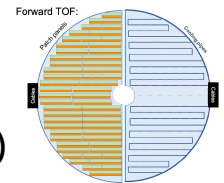

- Accurate space point for tracking / Low p PID
- Forward disk and central barrel

Bernd Surrow

ePIC Detector Layout

ePIC PID Detectors: Performance

Particle IDentification needs:

- Electrons from photons \rightarrow 4π coverage in tracking
- Electrons from charged hadrons \rightarrow mostly provided by calorimetry and tracking
- Charged pions, kaons, and protons from each other on track level \rightarrow Cherenkov detectors, complemented by ToF

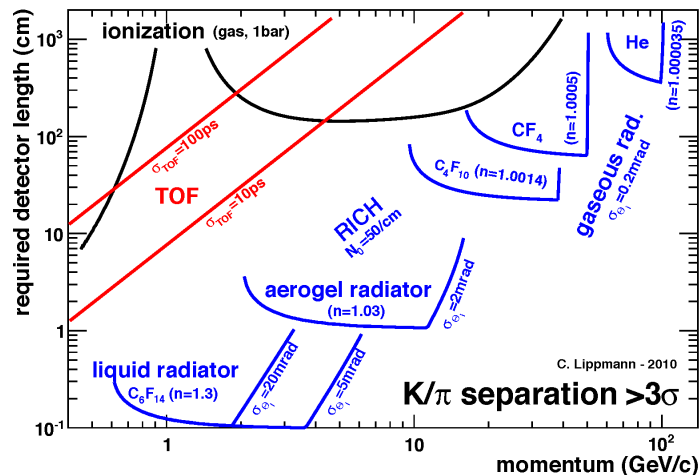

Critical: Need more than one technology to cover the **entire momentum ranges** at **different rapidities!**

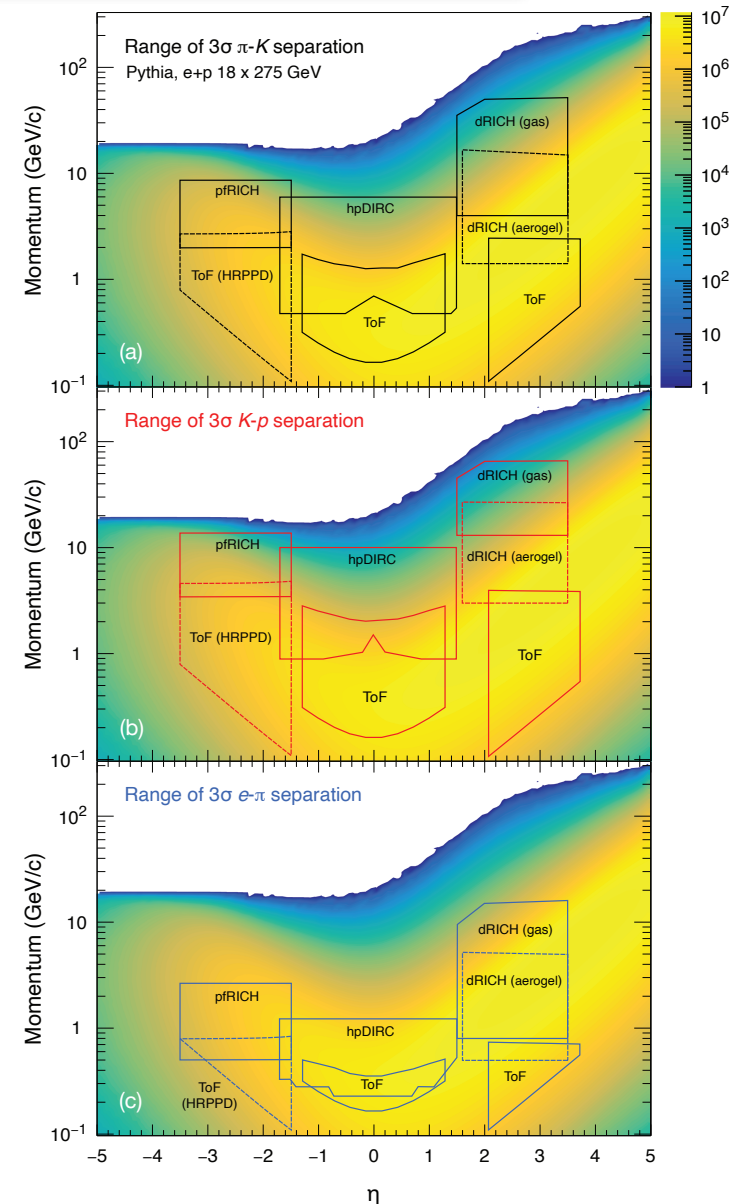

ePIC Detector Layout

FarBackward system

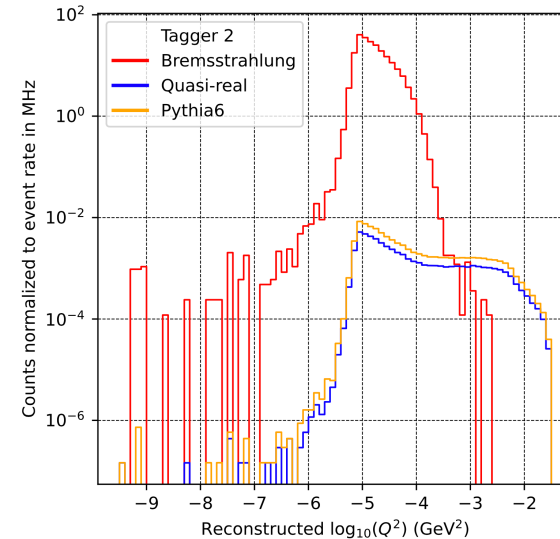
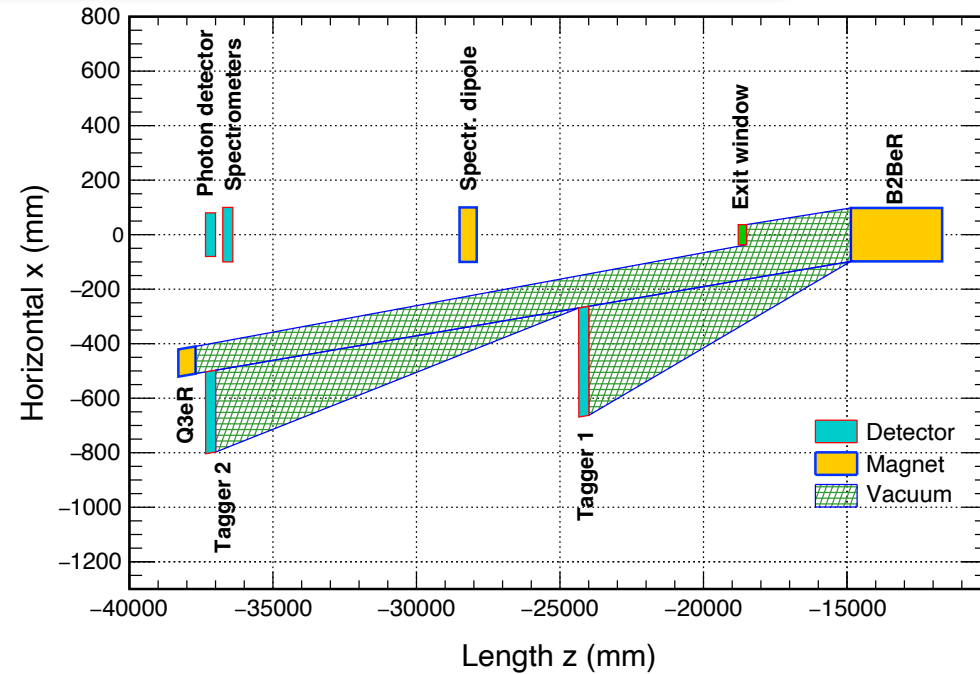
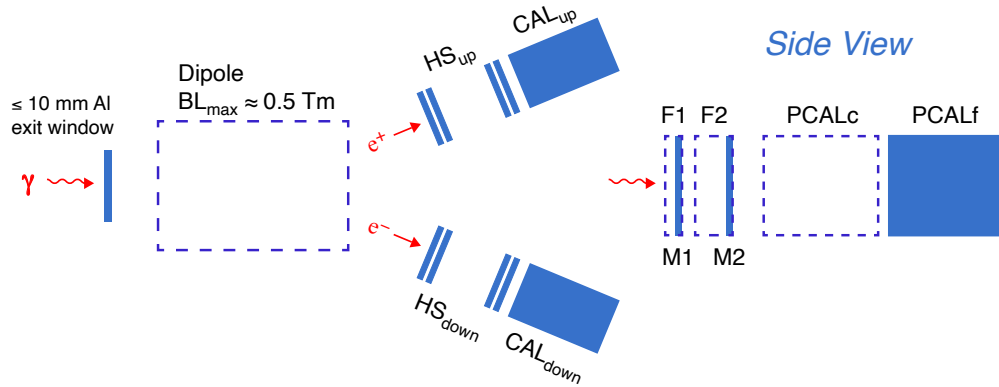

- High precision luminosity measurement at 1% level for **absolute luminosity** and 0.01% for **relative luminosity**

measurement using several methods based on the

Bremsstrahlung process:

- Counting photons converted in thin exit window using dipole field and measuring e^+e^- pairs
- Energy measurement of unconverted photons
- Counting of unconverted photons

- Low Q^2 taggers - **PHP tagger**

ePIC Detector Layout

FarForward detector system

- FarForward detector system to measure very forward neutral and charged particle production: 4 detector systems
- B0 system:** Measures charged particles in the forward direction and tags neutral particles
- Off-momentum detectors:** Measure charged particles resulting from decays
- Roman pot detectors:** Measure charged particles near the beam
- Zero-degree calorimeter:** Measures neutral particles at small angles

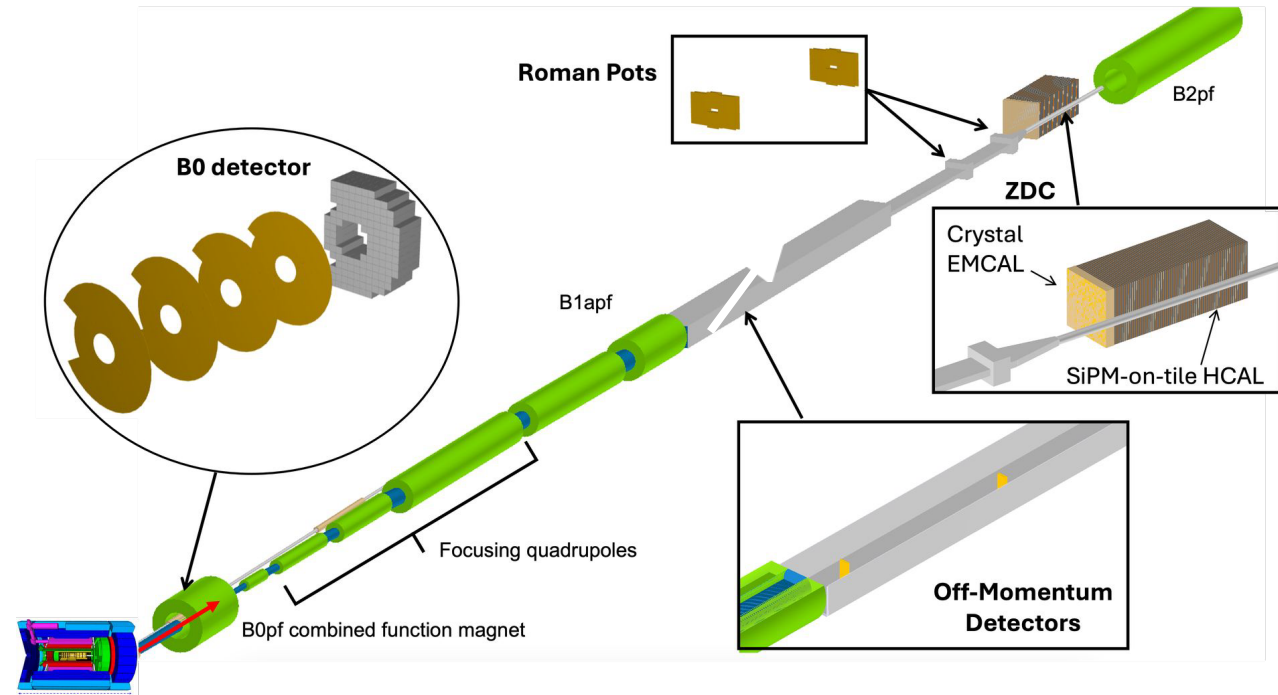

Detector	θ accep. [mrad]	Rigidity accep.	Particles	Technology
B0 tracker	5.5–20.0	N/A	Charged particles Tagged photons	MAPS AC-LGAD
Off-Momentum Detector	0.0–5.0	45%–65%	Charged particles	AC-LGAD
Roman Pots	0.0–5.0	60%–95%*	Protons Light nuclei	AC-LGAD
Zero-Degree Calorimeter	0.0–4.0	N/A	Neutrons Photons	W/SciFi (ECal) Pb/Sci (HCal)

ePIC Collaboration

World Map - Institutions



ePIC - A **global** pursuit for a new EIC experiment at IP6 at BNL

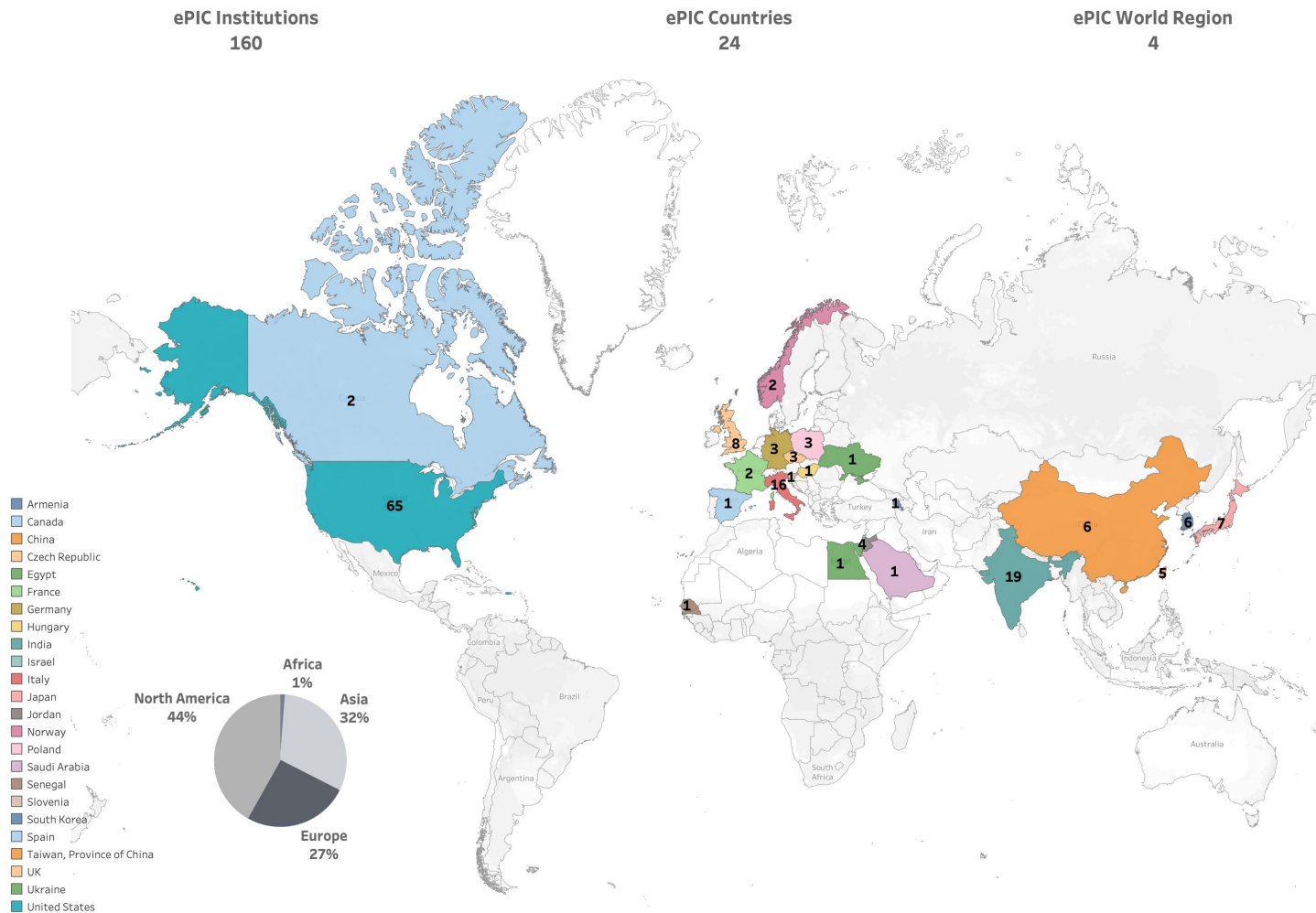

ePIC Collaboration

Number of Institutions

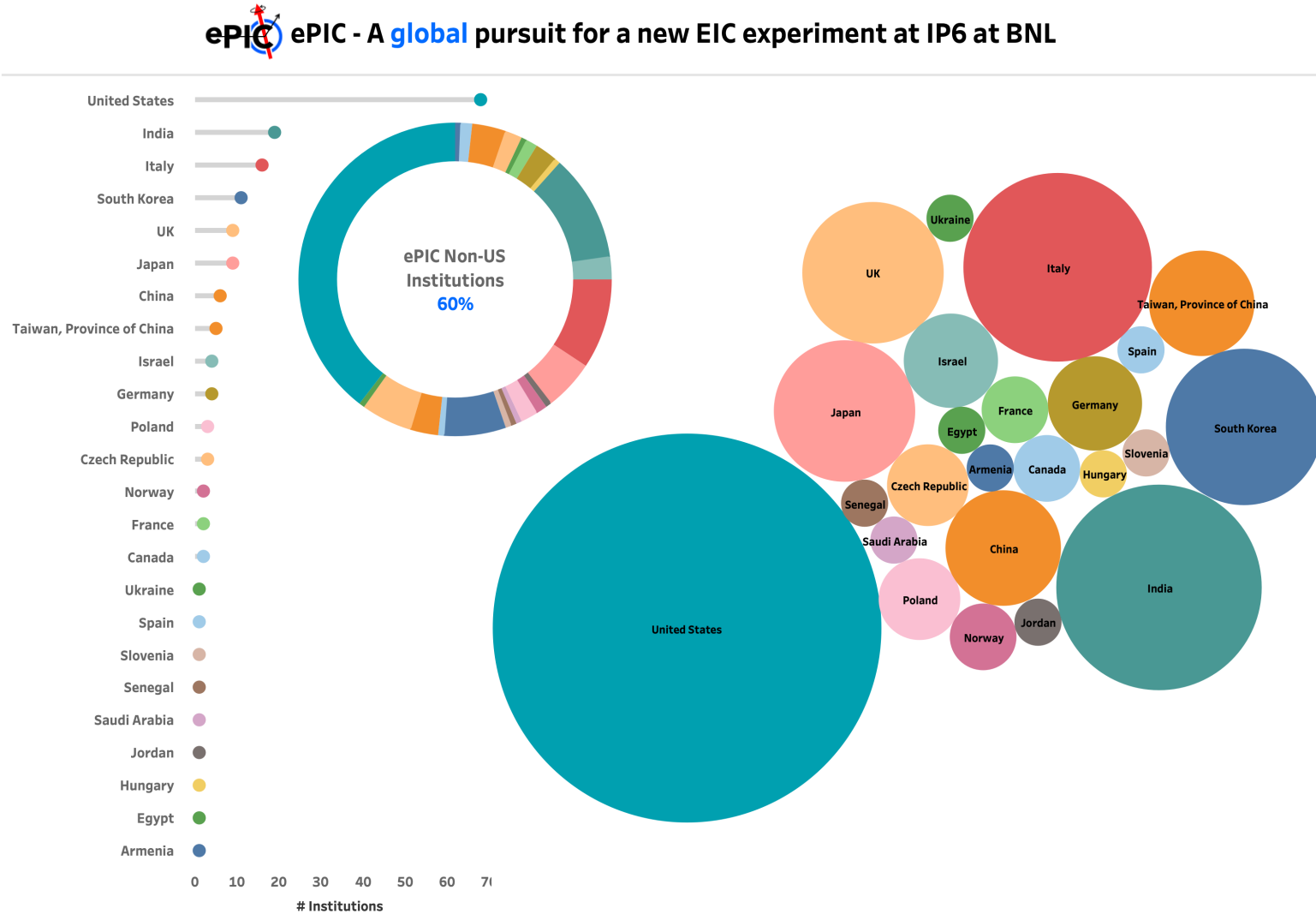

ePIC Collaboration

□ Collaboration

JLab, January 2023



Warsaw, July 2023

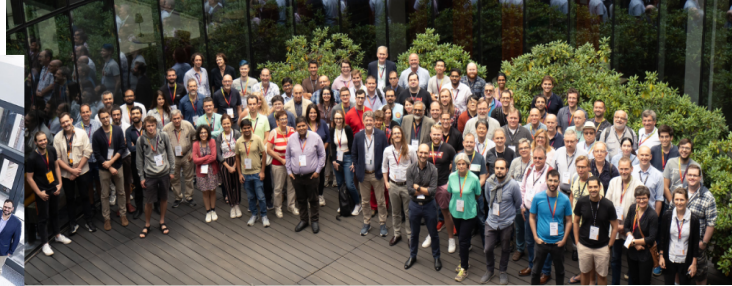

Lehigh, July 2024



ANL, January 2024



Frascati, Jan 2025



○ Vibrant *ePIC community* on physics and detector studies

○ *World-wide ePIC collaboration meetings*



Summary and Next Steps



Summary and Next Steps

- Over two decades, the nuclear physics community has developed the **scientific and technical case for the Electron-Ion Collider**, to push the **frontiers of human understanding of the fundamental structure and dynamics of matter** → **Emergent phenomena** in QCD!



Summary and Next Steps

- Over two decades, the nuclear physics community has developed the **scientific and technical case for the Electron-Ion Collider**, to push the **frontiers of human understanding of the fundamental structure and dynamics of matter** → **Emergent phenomena** in QCD!
- Enormously profit from a **diverse set of experiences among experimentalists and theorists** at numerous institutions **worldwide** → Critical for a **broad EIC scientific program**



Summary and Next Steps

- Over two decades, the nuclear physics community has developed the **scientific and technical case for the Electron-Ion Collider**, to push the **frontiers of human understanding of the fundamental structure and dynamics of matter** → **Emergent phenomena** in QCD!
- Enormously profit from a **diverse set of experiences among experimentalists and theorists** at numerous institutions **worldwide** → Critical for a **broad EIC scientific program**
- **Successful merging of several proposal efforts**, forming a new collaboration in 2022/2023:
ePIC collaboration

Summary and Next Steps

- Over two decades, the nuclear physics community has developed the **scientific and technical case for the Electron-Ion Collider**, to push the **frontiers of human understanding of the fundamental structure and dynamics of matter** → **Emergent phenomena** in QCD!
- Enormously profit from a **diverse set of experiences among experimentalists and theorists** at numerous institutions **worldwide** → Critical for a **broad EIC scientific program**
- **Successful merging of several proposal efforts**, forming a new collaboration in 2022/2023: **ePIC** collaboration
- A 2nd experiment is strongly supported by the EIC community - Not part of the EIC project / Longer timescale!

Summary and Next Steps

- Over two decades, the nuclear physics community has developed the **scientific and technical case for the Electron-Ion Collider**, to push the **frontiers of human understanding of the fundamental structure and dynamics of matter** → **Emergent phenomena** in QCD!
- Enormously profit from a **diverse set of experiences among experimentalists and theorists** at numerous institutions **worldwide** → Critical for a **broad EIC scientific program**
- **Successful merging of several proposal efforts**, forming a new collaboration in 2022/2023: **ePIC** collaboration
- A 2nd experiment is strongly supported by the EIC community - Not part of the EIC project / Longer timescale!
- A **very exciting time is ahead of us** to explore the structure and dynamics of matter at a new ep/eA collider facility following years of preparation - Join us!

Thank you!

Thank you to my friends and faculty colleagues

Andreas Metz and Alexey Prokudin

for numerous EIC physics discussions!



Andreas
Metz



Alexei
Prokudin